

F080E 人机界面

Kinco 步科

安装说明

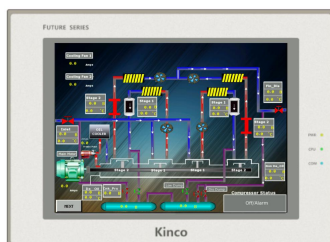

深圳市步科电气有限公司



电话: 0755-26585555

传真: 0755-26616372

技术支持热线: 400-700-5281

http://www.kinco.cn Email: sales@kinco.cn

步科官方微信

地址: 深圳市南山区高新科技园北区朗山一路6号一栋

1. 安装注意事项

1.1 环境要求

工作环境温度: F080E 人机界面的设计规范可以保证它能够在 14°F~131°F (-10~55°C) 的大多数工业环境中稳定工作。NEMA 防护规定: F080E 人机界面的前面板符合 NEMA 4 的防护规定。

请勿在以下场所使用:

- 阳光直射处
- 周围温度和相对湿度超出规格的场所
- 温度急剧变化易引起结露的场所
- 有腐蚀性气体和可燃性气体的场所
- 尘埃、灰尘、盐分、铁粉较多的场所
- 会被溅到水、油、药品等飞沫的场所
- 给主机带来直接振动和冲击的场所

在以下场所使用时请采取屏蔽措施:

- 有静电或其它形式噪音处
- 有较强电磁场的场所
- 可能暴露于射线的场所
- 靠近于动力电源的场所

1.2 电源要求

- 输入电压: DC12V~DC28V。
- 特别需要注意与变频调速器和开关电源供应器保持较远的距离, 这类设备的输入和输出电缆都必须采用屏蔽电缆, 并将屏蔽网接到系统的星形接地点。
- 直流电源必须与交流主电源正确地隔离开。
- 不要让 F080E 人机界面和感性负载或控制器的输入电路共用电源。
 - 产品内部的快速熔丝在电源电压过高的时候可以起到保护作用, 但不能确保内部电子元件不被损坏。

2. 产品安装

2.1 尺寸图

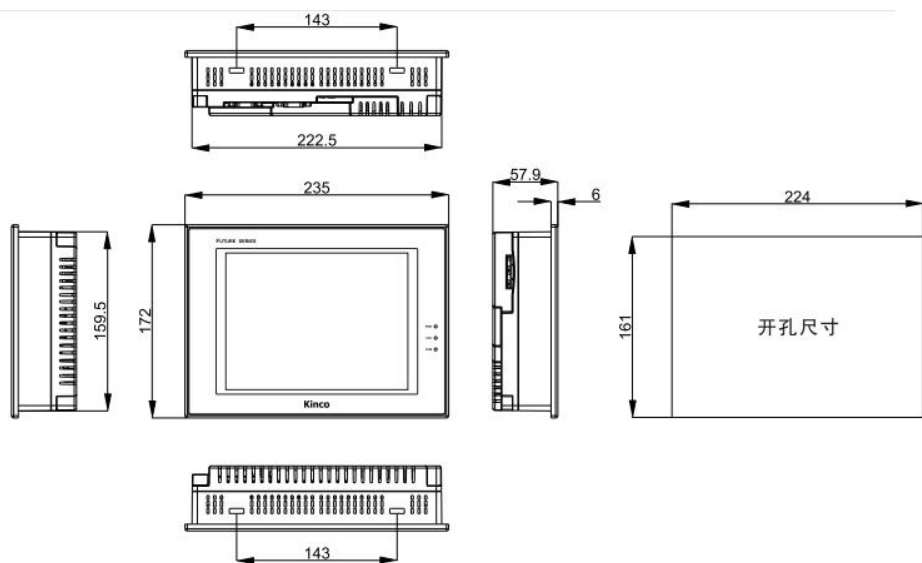

2.2 固定螺钉安装说明

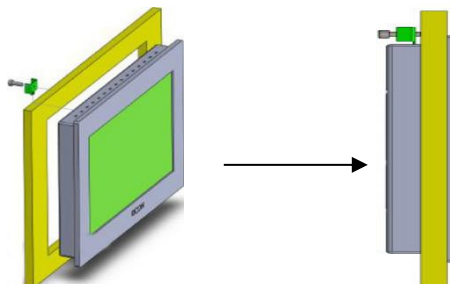

把产品放入面板上开好的安装孔中, 从面板背面将安装螺钉分别卡入产品外壳周围的 4 个安装螺钉固定孔, 然后逐个锁紧安装螺钉, 直到产品牢靠地固定在面板上。推荐扭力: 0.5N.m (以达到防水、防尘效果及避免外壳变形)。

- 为保证符合 NEMA-4 的密封规范, 所有的随产品提供的安装固定螺钉必须使用, 并且安装面板的弯曲度不能超过 0.010"。
- 不要过分用力锁紧安装螺钉!

2.3 电源连接

在连接电源前, 请确认符合所有当地和国家的电气标准。电源线缆请选择耐压值和电流值符合安全规定的线缆。

将产品背面接线端子的螺丝按逆时针方向旋松, 插入已经压接了端子的电源电缆, 然后顺时针拧紧接线端子的螺丝。**注意:** 将电源的正极接到标有 'DC24V' 的端子上, 直流的地接到标有 'GND' 的端子上, 地线接到标有 'FG' 的端子上。

3. 外部接口

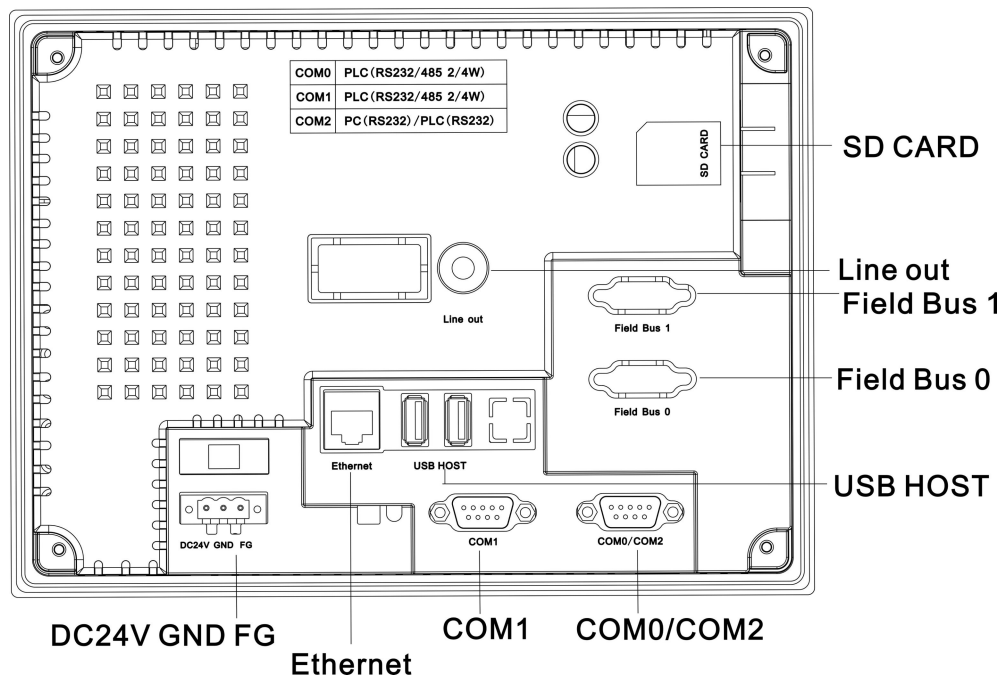

3.1 电源端子

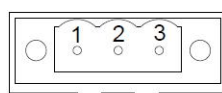

序号	含义
1	DC24V
2	GND
3	FG

3.2 COM0&COM2

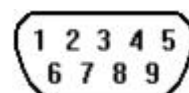

COM0&COM2 通讯端口是 9 针 D 型公座。**注意:** COM0 支持 RS232/485/422 通讯功能, 一个串口同时只能支持一种协议。COM2 支持 RS232 通讯功能。

管脚	信号	COM0 [RS-422]	COM0 [RS-485]	COM0 [RS-232]	COM2 [RS-232]
1	Rx- (A)	RS485 接收	RS485A		
2	RxD_PLC			RS232 接收	
3	TxD_PLC			RS232 发送	
4	Tx-	RS485 发送			
5	GND	信号地			
6	Rx+ (B)	RS485 接收	RS485B		
7	RxD_PC				RS232 接收
8	TxD_PC				RS232 发送
9	Tx+	RS485 发送			

3.3 COM1

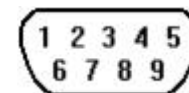

COM1 通讯端口是 9 针 D 型公座。COM1 支持 RS232/485/422 通讯功能, 一个串口同时只能支持一种协议。

管脚	信号	COM1 [RS-422]	COM1 [RS-485]	COM1 [RS-232]
1	Rx- (A)	RS485 接收	RS485A	
2	RxD_PLC			RS232 接收
3	TxD_PLC			RS232 发送
4	Tx-	RS485 发送		
5	GND	信号地		
6	Rx+ (B)	RS485 接收	RS485B	
9	Tx+	RS485 发送		

3.4 以太网接口

产品外壳背面的以太网接口为 10M/100M 自适应以太网端口。

连接	通过标准以太网线 (RJ45 直连线) 与 HUB 或者 SWITCH 相连, 接入局域网; 也可以通过双机互联网线 (RJ45 交叉线) 直接与 PC 网口连接。
端口作用	用于 HMI 组态的上/下载, 系统参数的设置和在线模拟; 构成多 HMI 联机; 与 PLC 等通过以太网通讯; 通过以太网口与 PC 机通讯。

3.5 USB HOST 接口 *2

连接	连接 USB 接口设备或 U 盘
端口作用	连接 USB 接口键盘、鼠标、打印机等, 插入 U 盘上传/下载程序以及存储数据

3.6 SD 卡接口

连接	标准 SD 卡 (24mm×32mm×2.1mm) 接口
端口作用	通过此接口插入 SD 卡进行数据拷贝存储以及程序上传/下载

3.7 音频接口

连接	标准 3.5mm 音频输出接口
端口作用	在软件组态中加入音频文件, 可通过组态程序实现语音输出, 当现场产生特殊的事件时, 输出语音信息, 实现人与机器的信息交流。

4. 售后服务

《人机界面售后服务条款》请登录如下网址查看: <http://www.kinco.cn>

Installation Instruction

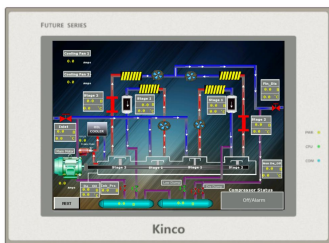

Kinco Electric (Shenzhen) Ltd.

Add: Building 1, No. 6 Langshan 1st Rd, Hi-tech Park North, Nanshan, Shenzhen, China.
 Tel: 0755-26585555 Fax: 0755-26616372 http://www.kinco.cn Email: sales@kinco.cn

1. Installation Note

1.1 Environmental Requirement

Operating temperature: F080E HMI can work stably in most industrial environments that the temperature between 14°F~131°F (-10~55°C) .

NEMA rating: This Series HMI frontpanel is NEMA 4 rated.

<p>Please do not use in the following places:</p> <ul style="list-style-type: none"> ➢ Places direct in sunlight ➢ Surrounding temperature and humidity beyond the specifications ➢ Places of temperature change sharply and easily cause condensation ➢ Places that exist corrosive gas and combustible gas ➢ Places of much dust, dirt, salt and iron powder ➢ Places that will be splashed water, oil and drugs ➢ Places that bring direct vibration and shock to host 	<p>Please take shielding measures in the following places:</p> <ul style="list-style-type: none"> ➢ Places that exist electrostatic or other kinds of noise ➢ Places of strong electromagnetic ➢ Places that may be exposed to rays ➢ Places near the power
---	--

1.2 Power Requirement

- Input voltage: DC12V~DC28V
- Particularly note that there must be enough distance between this product and converters or switch mode power supply. Make sure that the input and output cables of that kind equipment are shield cable and the shielding network is connected with the ground.
- Make sure that the DC power and AC power is isolated.
- Do not use common power with perceptual load or input circuit of the controller.
 - An Internal fuse will prevent damage for over voltage condition, however it isn't guaranteed the internal electronic components are not damaged..

2. Installation Description

2.1 Dimensional Drawing

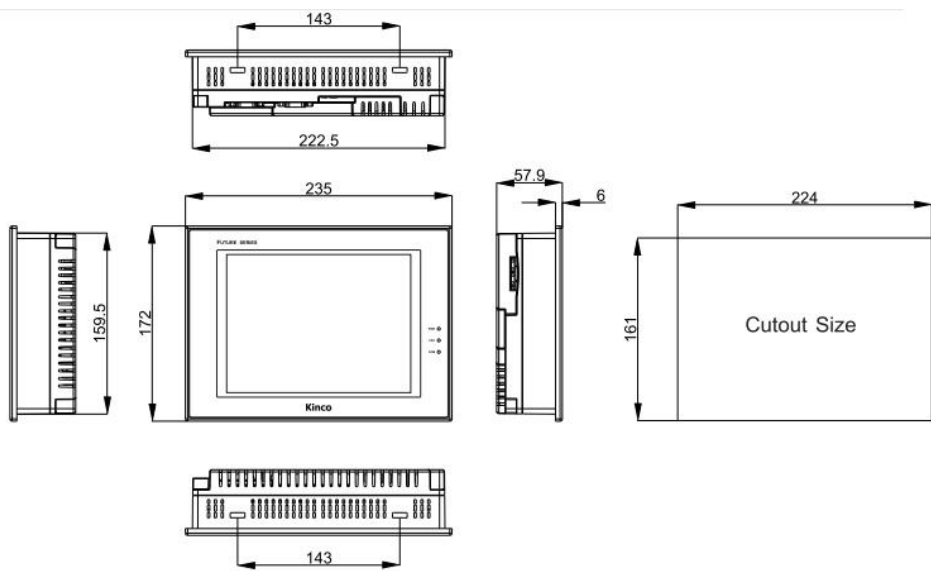

2.2 Fixed Screw Installation Instructions

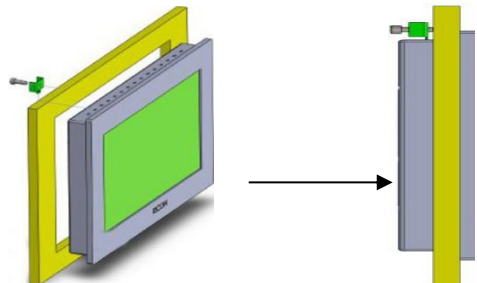

Put the unit through the panel cut out. Slide the clamps into the 4 holes provided around the case. Tighten the clamping screws in an even pattern until the unit is secured in the panel. Recommended lock torque: 0.5N.m (to waterproof effect and avoid shell deformation)

- To seal to NEMA-4 specifications, all supplied mounting clamps must be used and panel cannot flex more than 0.010"
- Do not over-tighten mounting clamps!

2.3 Power Connections

Before connecting the power, please make sure all local and national electrical standards are met. For power cables, please select cables with their dielectric strength values and current values in compliance with the safety specifications.

First find the power terminal at the back of the product and loosen the screw according to counterclockwise, then insert the power cables and tighten the screw up.

Connect positive DC line to the 'DC24V' terminal, the DC ground to the 'GND' terminal and the ground line to the 'FG' terminal.

3. External Interface

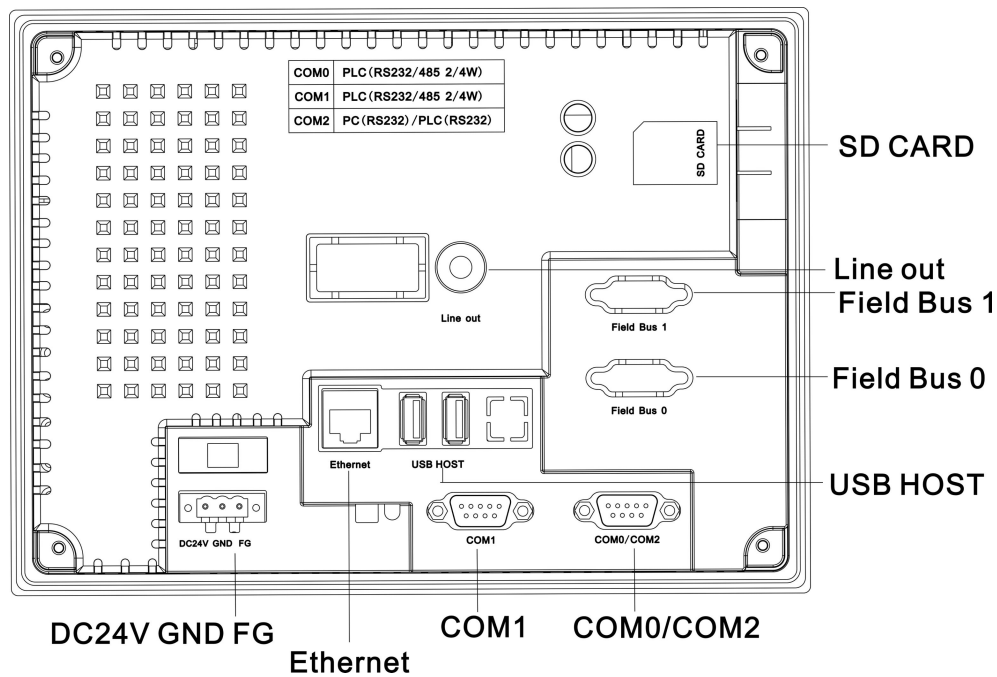

3.1 POWER

Pin#	Signal
1	DC24V
2	GND
3	FG

3.2 COM0&COM2

Pin assignment of the 9-pin male, D-SUB, COM0&COM2. **Note:** RS232/485/422 communication functions are supported by COM0. COM2 supports RS232 communication function.

Pin	Signal	COM0 [RS-422]	COM0 [RS-485]	COM0 [RS-232]	COM2 [RS-232]
1	Rx-(A)	RS-485 Rx	RS485 A		
2	RxD_PLC			RS-232 Rx	
3	TxD_PLC			RS-232 Tx	
4	Tx-	RS-485 Tx			
5	GND	Signal Ground			
6	Rx+(B)	RS-485 Rx	RS485 B		
7	RxD_PC				RS-232 Rx
8	TxD_PC				RS-232 Tx
9	Tx+	RS-485 Tx			

3.3 COM1

Pin assignment of the 9-pin male, D-SUB, COM1. **Note:** RS232/485/422 communication functions are supported by COM1.

Pin	Signal	COM1 [RS-422]	COM1 [RS-485]	COM1 [RS-232]
1	Rx-(A)	RS-485 Rx	RS485A	
2	RxD_PLC			RS-232 Rx
3	TxD_PLC			RS-232 Tx
4	Tx-	RS-485 Tx		
5	GND	Signal ground		
6	Rx+(B)	RS-485 Rx	RS485B	
9	Tx+	RS-485 Tx		

3.4 Ethernet

Connection	This port is connected with the HUB or Switch through a standard Ethernet cable (RJ-45 straight-through cable) and then connected to a LAN. It can also be directly connected with the Ethernet port of a PC through a dual system interconnection cable (RJ-45 crossover cable).
Port Function	The port can be used for upload/download of HMI configuration, setting of system parameters and online simulations of configurations. It can connect multiple HMIs via the Ethernet to form an HMI network. Furthermore, it can implement communications between HMI and PLC via the Ethernet, as well as communications with a PC via the Ethernet port.

3.5 USB HOST *2

Connection	Connect with USB interface devices or U disks
Port Function	This interface can be connected with USB keyboard, mouse and printers, and the U disk can be used for user's configuration uploading/ downloading as well as data storage.

3.6 SD CARD

Connection	Standard SD card interface
Port Function	The SD Card can be inserted in through this interface for Data storage and user configuration uploading/downloading.

3.7 Audio Interface

Connection	Standard 3.5mm Audio Output Interface
Port Function	Audio Files are added in the configuration in advanced, the audio signal will produced when specific events occurred..

4. After-sales Service

For < Service Terms and Conditions for HMI >, please check: <http://www.kinco.cn>