

## 规格书 | 型号: 2102-1301

3线普通接线端子; 具有操作手柄及直插型笼式弹簧接线单元; 2.5 mm<sup>2</sup>; 有测试插孔; 侧面/中心标记; 适于35 x 15 和 35 x 7.5导轨; Push-in CAGE CLAMP®; 2,50 mm<sup>2</sup>; 灰色

[www.wago.com/2102-1301](http://www.wago.com/2102-1301)

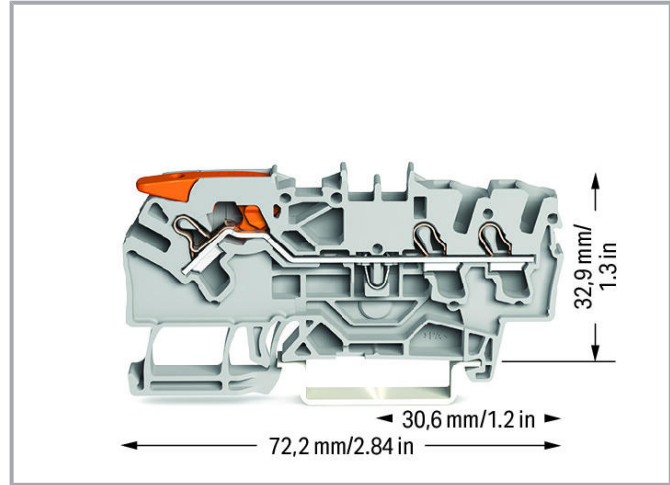
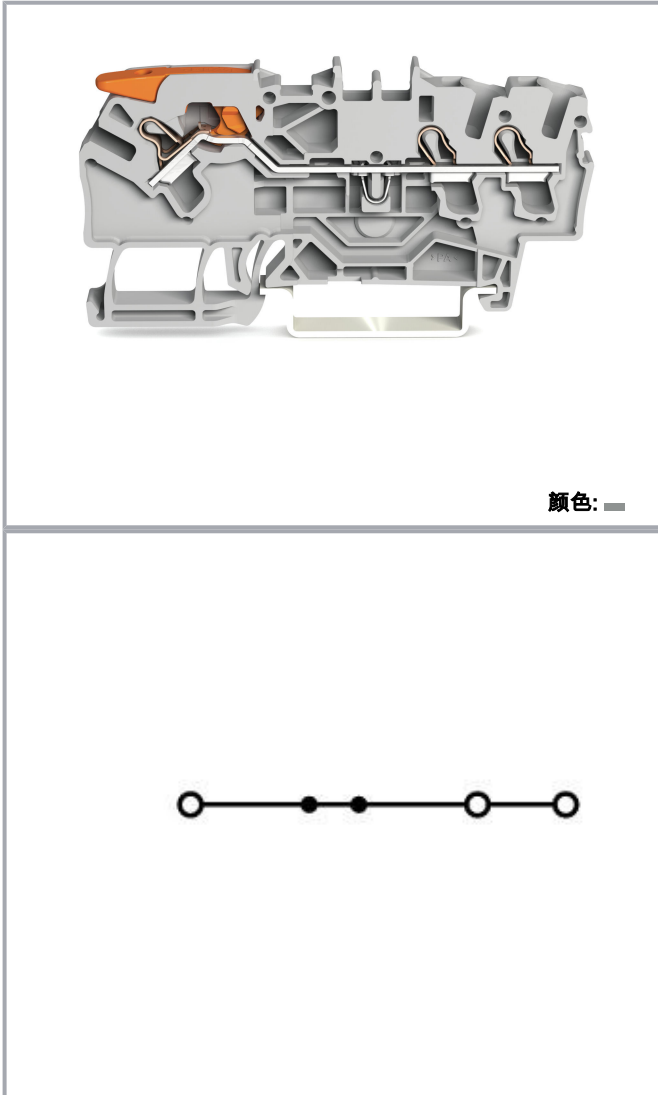

## 数据

### 电气参数

## Ratings per IEC/EN

额定电气参数依据的标准

IEC/EN 60947-7-1

变更声明。敬请关注进一步的产品说明文件！

WAGO Electronic (Tianjin) Co., Ltd.  
No.5, Quan Hui Road  
Wuqing Development Area | Tianjin 301700  
Tel.: +86 22 59677688 | Fax: +86 22 59617668  
Email: info-cn@wago.com

您有关于我们产品的任何问题吗？  
我们非常乐意接听您的来电，+86 (022) 59677688。

额定电压(III/3)	800 V
额定浪涌电压(III/3)	8 kV
额定电流	24 A
额定电流2	30 A
图例(额定电气参数)	(III / 3) △ 过电压类别III/污染等级3

### Approvals per UL

认证	UL 1059
额定电压 UL(Use Group B)	600 V
额定电流 UL(Use Group B)	20 A
额定电压 UL(Use Group C)	600 V
额定电流 UL(Use Group C)	20 A

### Approvals per CSA

认证	C22.2 No 158
额定电压 CSA (Use Group B)	600 V
额定电流 CSA (Use Group B)	20 A
额定电压 CSA (Use Group C)	600 V
额定电流 CSA (Use Group C)	20 A

### Ex information

Ratings per	ATEX: PTB 18 ATEX 1010 U / IECEx: PTB 18.0001U (Ex eb IIC Gb)
额定电压EN (Ex e II)	550 V
额定电流(Ex e II)	23.5 A
带跨接器时的额定电流((Ex e II)	20 A

### 接线参数

连接技术	直插型笼式弹簧接线单元(Push-in CAGE CLAMP®)
执行类型	推入式 操作手柄
执行类型2	推入式 操作工具
可连接导线材料	铜
额定导线截面积	2.5 mm <sup>2</sup>
单股导线	0.25 ... 4 mm <sup>2</sup> / 22 ... 12 AWG
单股导线 ; 可直接插入	0.75 ... 4 mm <sup>2</sup> / 18 ... 12 AWG
细多股导线	0.25 ... 4 mm <sup>2</sup> / 22 ... 12 AWG

变更声明。 敬请关注进一步的产品说明文件！

WAGO Electronic (Tianjin) Co., Ltd.  
No.5, Quan Hui Road  
Wuqing Development Area | Tianjin 301700  
Tel.: +86 22 59677688 | Fax: +86 22 59617668  
Email: info-cn@wago.com

您有关于我们产品的任何问题吗？  
我们非常乐意接听您的来电， +86 (022) 59677688。



细多股导线；加有带绝缘护套的冷压接头	0.25 ... 2.5 mm <sup>2</sup> / 22 ... 14 AWG
细多股导线；加有冷压接头；可直接插入	1 ... 2.5 mm <sup>2</sup> / 18 ... 14 AWG
说明(导线截面积)	横截面较小的导线也可以直接插入,具体取决于导线特性。
剥线长度	10 ... 12 mm / 0.39 ... 0.47 英寸
连接点总数	3
电位总数量	1
层数	1
接线类型	正面接线
跨接器插孔数量	2

### Geometrical Data

宽度	5.2 mm / 0.205 inch
高度	72.2 mm / 2.843 inch
以DIN导轨的上边线为基准的深度	32.9 mm / 1.295 inch

### 机械参数

设计	水平型
安装方式	DIN-35型导轨
标记位	中央/侧面标记位

### 材料参数

颜色	灰色
绝缘材料	尼龙66 (PA 66)
重量	8.1 g

### 商业数据

包装类型	BOX
原产国	DE
GTIN	4055143741798
海关税号	85369010000

### 认证 / 证书

#### Ex防爆认证





标识	认证	其他认证信息	认证名称
	<b>AEx</b> Underwriters Laboratories Inc.	UL 60079	20181105-E185892

变更声明。敬请关注进一步的产品说明文件！

WAGO Electronic (Tianjin) Co., Ltd.  
No.5, Quan Hui Road  
Wuqing Development Area | Tianjin 301700  
Tel.: +86 22 59677688 | Fax: +86 22 59617668  
Email: info-cn@wago.com

您有关于我们产品的任何问题吗？  
我们非常乐意接听您的来电，+86 (022) 59677688。

## AEx

	<b>ATEX</b> Physikalisch Technische Bundesanstalt	EN 60079-0	PTB 18 ATEX 1010 U
	<b>CCCEX</b> CQST/CNEEx	CNCA-C23-01	2020312313000163
	<b>EAC</b> Brjansker Zertifizierungsstelle	TP TC 012/2011	RU C-DE.AM02.B. 00127/19
	<b>IECEX</b> Physikalisch Technische Bundesanstalt	IEC 60079-0	IECEX PTB 18.0017U

### 船级社认证

标识	认证	其他认证信息	认证名称
	<b>CCA</b> DEKRA Certification B.V.	EN 60947	NTR NL 7670
	<b>CSA</b> DEKRA Certification B.V.	C22.2	70175030
	<b>KEMA/KEUR</b> DEKRA Certification B.V.	EN 60947	71- 102882

### 船级社认证

标识	认证	其他认证信息	认证名称
	<b>ABS</b> American Bureau of Shipping	-	19- HG1866350- PDA
	<b>DNV GL</b> Det Norske Veritas, Germanischer Lloyd	-	TAE00003JT

变更声明。敬请关注进一步的产品说明文件！

WAGO Electronic (Tianjin) Co., Ltd.  
No.5, Quan Hui Road  
Wuqing Development Area | Tianjin 301700  
Tel.: +86 22 59677688 | Fax: +86 22 59617668  
Email: [info-cn@wago.com](mailto:info-cn@wago.com)

您关于我们产品的任何问题吗？  
我们非常乐意接听您的来电， +86 (022) 59677688。



LR

Lloyds Register



19/20050

## UL-Approvals

标识	认证	其他认证信息	认证名称
	cURus Underwriters Laboratories Inc.	UL 1059	20190731- E45172

## 所需附件

## End plate

	<b>型号: 2102-1391</b> 端板和隔板; 厚度 0.8 mm; 适用于3线接线端子; 灰色	<a href="http://www.wago.com/2102-1391">www.wago.com/2102-1391</a>
	<b>型号: 2102-1392</b> 端板和隔板; 厚度 0.8 mm; 适用于3线接线端子; 橙色	<a href="http://www.wago.com/2102-1392">www.wago.com/2102-1392</a>

## 适用产品

## Carrier rail

	<b>型号: 210-112</b> 钢质导轨; 35 x 7.5 mm; 厚度 1 mm; 长度 2 m; 带孔; 符合 EN 60715标准; "孔宽25 mm; 银色	<a href="http://www.wago.com/210-112">www.wago.com/210-112</a>
	<b>型号: 210-113</b> 钢质导轨; 35 x 7.5 mm; 厚度 1 mm; 长度 2 m; 不带孔; 符合 EN 60715标准; 银色	<a href="http://www.wago.com/210-113">www.wago.com/210-113</a>
	<b>型号: 210-114</b> 钢质导轨; 35 x 15 mm; 厚度 1.5 mm; 长度 2 m; 不带孔; 类似于EN 60715; 银色	<a href="http://www.wago.com/210-114">www.wago.com/210-114</a>
	<b>型号: 210-115</b> 钢质导轨; 35 x 7.5 mm; 厚度 1 mm; 长度 2 m; 带孔; 符合 EN 60715标准; "孔宽18 mm; 银色	<a href="http://www.wago.com/210-115">www.wago.com/210-115</a>
	<b>型号: 210-118</b> 钢质导轨; 35 x 15 mm; 厚度 2.3 mm; 长度 2 m; 不带孔; 符合 EN 60715标准; 银色	<a href="http://www.wago.com/210-118">www.wago.com/210-118</a>
	<b>型号: 210-196</b> 铝质导轨; 35 x 8.2 mm; 厚度 1.6 mm; 长度 2 m; 不带孔; 类似于EN 60715; 银色	<a href="http://www.wago.com/210-196">www.wago.com/210-196</a>
	<b>型号: 210-197</b>	

变更声明。敬请关注进一步的产品说明文件！

WAGO Electronic (Tianjin) Co., Ltd.  
No.5, Quan Hui Road  
Wuqing Development Area | Tianjin 301700  
Tel.: +86 22 59677688 | Fax: +86 22 59617668  
Email: info-cn@wago.com

您有关于我们产品的任何问题吗？  
我们非常乐意接听您的来电， +86 (022) 59677688。

	钢质导轨; 35 x 15 mm; 厚度 1.5 mm; 长度 2 m; 带孔; 类似于EN 60715; 银色	<a href="http://www.wago.com/210-197">www.wago.com/210-197</a>
	<b>型号: 210-198</b> 铜质导轨; 35 x 15 mm; 厚度 2.3 mm; 长度 2 m; 不带孔; 符合 EN 60715标准; 铜色	<a href="http://www.wago.com/210-198">www.wago.com/210-198</a>
<b>plug</b>		
	<b>型号: 2002-880</b> 空插头; 宽度10.4 mm; 2极; 4类; 灰色	<a href="http://www.wago.com/2002-880">www.wago.com/2002-880</a>
	<b>型号: 2002-880/1000-411</b> 元件插头; 2极; 带有1个二极管 1N4007; 宽度10.4 mm; 工作温度最高 85°C; 灰色	<a href="http://www.wago.com/2002-880/1000-411">www.wago.com/2002-880/1000-411</a>
	<b>型号: 2002-880/1000-541</b> 元件插头; 2极; 红色LED; 宽度10.4 mm; 工作温度最高 85°C; 灰色	<a href="http://www.wago.com/2002-880/1000-541">www.wago.com/2002-880/1000-541</a>
	<b>型号: 2002-880/1000-542</b> 元件插头; 2极; 红色LED; 宽度10.4 mm; 工作温度最高 85°C; 多种颜色	<a href="http://www.wago.com/2002-880/1000-542">www.wago.com/2002-880/1000-542</a>
	<b>型号: 2002-880/1000-836</b> 元件插头; 2极; 红色LED; 宽度10.4 mm; 工作温度最高 85°C; 灰色	<a href="http://www.wago.com/2002-880/1000-836">www.wago.com/2002-880/1000-836</a>
<b>Insulation stop</b>		
	<b>型号: 2002-171</b> 绝缘挡块; 0.25 - 0.5 mm <sup>2</sup> ; 5件/条; 浅灰色	<a href="http://www.wago.com/2002-171">www.wago.com/2002-171</a>
	<b>型号: 2002-172</b> 绝缘挡块; 0.75 - 1 mm <sup>2</sup> ; 5件/条; 深灰色	<a href="http://www.wago.com/2002-172">www.wago.com/2002-172</a>
<b>Push-In type wire jumper</b>		
	<b>型号: 2009-412</b> 推入式跨接器; 绝缘; 长度60 mm; 黑色	<a href="http://www.wago.com/2009-412">www.wago.com/2009-412</a>
	<b>型号: 2009-414</b> 推入式跨接器; 1.5 mm <sup>2</sup> ; 绝缘; 长度110 mm; 黑色	<a href="http://www.wago.com/2009-414">www.wago.com/2009-414</a>
	<b>型号: 2009-414/000-005</b> 推入式跨接器; 1.5 mm <sup>2</sup> ; 绝缘; 长度110 mm; 黑色	<a href="http://www.wago.com/2009-414/000-005">www.wago.com/2009-414/000-005</a>
	<b>型号: 2009-414/000-006</b> 推入式跨接器; 绝缘; 长度110 mm; 黑色	<a href="http://www.wago.com/2009-414/000-006">www.wago.com/2009-414/000-006</a>
	<b>型号: 2009-416</b> 推入式跨接器; 1.5 mm <sup>2</sup> ; 绝缘; 长度250 mm; 黑色	<a href="http://www.wago.com/2009-416">www.wago.com/2009-416</a>
<b>ferrule</b>		
	<b>型号: 216-241</b> 冷压接头; 标识套管, 适用截面积 0.5 mm <sup>2</sup> / AWG 20; 绝缘; 电镀锡; 电解铜; 气密压接; 符合DIN 46288-4	<a href="http://www.wago.com/216-241">www.wago.com/216-241</a>

变更声明。敬请关注进一步的产品说明文件！

WAGO Electronic (Tianjin) Co., Ltd.  
No.5, Quan Hui Road  
Wuqing Development Area | Tianjin 301700  
Tel.: +86 22 59677688 | Fax: +86 22 59617668  
Email: info-cn@wago.com











您有关于我们产品的任何问题吗？  
我们非常乐意接听您的来电，+86 (022) 59677688。

	/09.09标准; 白色	
	<b>型号: 216-242</b> 冷压接头; 标识套管, 适用截面积 0.75 mm <sup>2</sup> / AWG 18; 绝缘; 电镀锡; 电解铜; 气密压接; 符合DIN 46288-4 /09.09标准; 灰色	<a href="http://www.wago.com/216-242">www.wago.com/216-242</a>
	<b>型号: 216-243</b> 冷压接头; 套管, 适于1 mm <sup>2</sup> / AWG 18; 绝缘; 电镀锡; 电解铜; 气密压接; 符合DIN 46288-4/09.09标准; 红色	<a href="http://www.wago.com/216-243">www.wago.com/216-243</a>
	<b>型号: 216-244</b> 冷压接头; 套管, 适于1.5 mm <sup>2</sup> / AWG 16; 绝缘; 电镀锡; 电解铜; 气密压接; 符合DIN 46288-4/09.09标准; 黑色	<a href="http://www.wago.com/216-244">www.wago.com/216-244</a>
	<b>型号: 216-246</b> 冷压接头; 套管, 适于2.5 mm <sup>2</sup> / AWG 14; 绝缘; 电镀锡; 电解铜; 气密压接; 符合DIN 46288-4/09.09标准; 蓝色	<a href="http://www.wago.com/216-246">www.wago.com/216-246</a>
	<b>型号: 216-262</b> 冷压接头; 标识套管, 适用截面积 0.75 mm <sup>2</sup> / AWG 18; 绝缘; 电镀锡; 电解铜; 气密压接; 符合DIN 46288-4 /09.09标准; 灰色	<a href="http://www.wago.com/216-262">www.wago.com/216-262</a>
	<b>型号: 216-263</b> 冷压接头; 套管, 适于1 mm <sup>2</sup> / AWG 18; 绝缘; 电镀锡; 电解铜; 气密压接; 符合DIN 46288-4/09.09标准; 红色	<a href="http://www.wago.com/216-263">www.wago.com/216-263</a>
	<b>型号: 216-264</b> 冷压接头; 套管, 适于1.5 mm <sup>2</sup> / AWG 16; 绝缘; 电镀锡; 电解铜; 气密压接; 符合DIN 46288-4/09.09标准; 黑色	<a href="http://www.wago.com/216-264">www.wago.com/216-264</a>
	<b>型号: 216-266</b> 冷压接头; 套管, 适于2.5 mm <sup>2</sup> / AWG 14; 绝缘; 电镀锡; 电解铜; 气密压接; 符合DIN 46288-4/09.09标准; 蓝色	<a href="http://www.wago.com/216-266">www.wago.com/216-266</a>
<b>Jumper</b>		
	<b>型号: 2002-400</b> 连续跨接器; 2插脚; 绝缘; 浅灰色	<a href="http://www.wago.com/2002-400">www.wago.com/2002-400</a>
	<b>型号: 2002-402</b> 跨接器; 2插脚; 绝缘; 浅灰色	<a href="http://www.wago.com/2002-402">www.wago.com/2002-402</a>
	<b>型号: 2002-402/000-005</b> 跨接器; 2插脚; 绝缘; 红色	<a href="http://www.wago.com/2002-402/000-005">www.wago.com/2002-402/000-005</a>
	<b>型号: 2002-402/000-006</b> 跨接器; 2插脚; 绝缘; 蓝色	<a href="http://www.wago.com/2002-402/000-006">www.wago.com/2002-402/000-006</a>
	<b>型号: 2002-403</b> 跨接器; 3插脚; 绝缘; 浅灰色	<a href="http://www.wago.com/2002-403">www.wago.com/2002-403</a>
	<b>型号: 2002-403/000-005</b> 跨接器; 3插脚; 绝缘; 红色	<a href="http://www.wago.com/2002-403/000-005">www.wago.com/2002-403/000-005</a>
	<b>型号: 2002-403/000-006</b> 跨接器; 3插脚; 绝缘; 蓝色	<a href="http://www.wago.com/2002-403/000-006">www.wago.com/2002-403/000-006</a>

变更声明。敬请关注进一步的产品说明文件！

WAGO Electronic (Tianjin) Co., Ltd.  
No.5, Quan Hui Road  
Wuqing Development Area | Tianjin 301700  
Tel.: +86 22 59677688 | Fax: +86 22 59617668  
Email: info-cn@wago.com

您有关于我们产品的任何问题吗？  
我们非常乐意接听您的来电，+86 (022) 59677688。

	<b>型号: 2002-404</b> 跨接器; 4插脚; 绝缘; 浅灰色	<a href="http://www.wago.com/2002-404">www.wago.com/2002-404</a>
	<b>型号: 2002-404/000-005</b> 跨接器; 4插脚; 绝缘; 红色	<a href="http://www.wago.com/2002-404/000-005">www.wago.com/2002-404/000-005</a>
	<b>型号: 2002-404/000-006</b> 跨接器; 4插脚; 绝缘; 蓝色	<a href="http://www.wago.com/2002-404/000-006">www.wago.com/2002-404/000-006</a>
	<b>型号: 2002-405</b> 跨接器; 5插脚; 绝缘; 浅灰色	<a href="http://www.wago.com/2002-405">www.wago.com/2002-405</a>
	<b>型号: 2002-405/000-005</b> 跨接器; 5插脚; 绝缘; 红色	<a href="http://www.wago.com/2002-405/000-005">www.wago.com/2002-405/000-005</a>
	<b>型号: 2002-405/000-006</b> 跨接器; 5插脚; 绝缘; 蓝色	<a href="http://www.wago.com/2002-405/000-006">www.wago.com/2002-405/000-006</a>
	<b>型号: 2002-405/011-000</b> 起点跨接器; 3插脚; 绝缘; 浅灰色	<a href="http://www.wago.com/2002-405/011-000">www.wago.com/2002-405/011-000</a>
	<b>型号: 2002-406</b> 跨接器; 6插脚; 绝缘; 浅灰色	<a href="http://www.wago.com/2002-406">www.wago.com/2002-406</a>
	<b>型号: 2002-406/000-005</b> 跨接器; 6插脚; 绝缘; 红色	<a href="http://www.wago.com/2002-406/000-005">www.wago.com/2002-406/000-005</a>
	<b>型号: 2002-406/000-006</b> 跨接器; 6插脚; 绝缘; 蓝色	<a href="http://www.wago.com/2002-406/000-006">www.wago.com/2002-406/000-006</a>
	<b>型号: 2002-406/020-000</b> 三角形接法跨接器; 绝缘; 浅灰色	<a href="http://www.wago.com/2002-406/020-000">www.wago.com/2002-406/020-000</a>
	<b>型号: 2002-407</b> 跨接器; 7插脚; 绝缘; 浅灰色	<a href="http://www.wago.com/2002-407">www.wago.com/2002-407</a>
	<b>型号: 2002-407/000-005</b> 跨接器; 7插脚; 绝缘; 红色	<a href="http://www.wago.com/2002-407/000-005">www.wago.com/2002-407/000-005</a>
	<b>型号: 2002-407/000-006</b> 跨接器; 7插脚; 绝缘; 蓝色	<a href="http://www.wago.com/2002-407/000-006">www.wago.com/2002-407/000-006</a>

变更声明。 敬请关注进一步的产品说明文件！

WAGO Electronic (Tianjin) Co., Ltd.  
No.5, Quan Hui Road  
Wuqing Development Area | Tianjin 301700  
Tel.: +86 22 59677688 | Fax: +86 22 59617668  
Email: [info-cn@wago.com](mailto:info-cn@wago.com)

您有关于我们产品的任何问题吗？  
我们非常乐意接听您的来电， +86 (022) 59677688。





**型号: 2002-408**  
跨接器; 8插脚; 绝缘; 浅灰色

[www.wago.com/2002-408](http://www.wago.com/2002-408)



**型号: 2002-408/000-005**  
跨接器; 8插脚; 绝缘; 红色

[www.wago.com/2002-408/000-005](http://www.wago.com/2002-408/000-005)



**型号: 2002-408/000-006**  
跨接器; 8插脚; 绝缘; 蓝色

[www.wago.com/2002-408/000-006](http://www.wago.com/2002-408/000-006)



**型号: 2002-409**  
跨接器; 9插脚; 绝缘; 浅灰色

[www.wago.com/2002-409](http://www.wago.com/2002-409)



**型号: 2002-409/000-005**  
跨接器; 9插脚; 绝缘; 红色

[www.wago.com/2002-409/000-005](http://www.wago.com/2002-409/000-005)



**型号: 2002-409/000-006**  
跨接器; 9插脚; 绝缘; 蓝色

[www.wago.com/2002-409/000-006](http://www.wago.com/2002-409/000-006)



**型号: 2002-410**  
跨接器; 10插脚; 绝缘; 浅灰色

[www.wago.com/2002-410](http://www.wago.com/2002-410)



**型号: 2002-410/000-005**  
跨接器; 10插脚; 绝缘; 红色

[www.wago.com/2002-410/000-005](http://www.wago.com/2002-410/000-005)



**型号: 2002-410/000-006**  
跨接器; 10插脚; 绝缘; 蓝色

[www.wago.com/2002-410/000-006](http://www.wago.com/2002-410/000-006)



**型号: 2002-423**  
连续跨接器; 从1到3; 绝缘; 浅灰色

[www.wago.com/2002-423](http://www.wago.com/2002-423)



**型号: 2002-423/000-005**  
连续跨接器; 从1到3; 绝缘; 红色

[www.wago.com/2002-423/000-005](http://www.wago.com/2002-423/000-005)



**型号: 2002-423/000-006**  
连续跨接器; 从1到3; 绝缘; 蓝色

[www.wago.com/2002-423/000-006](http://www.wago.com/2002-423/000-006)



**型号: 2002-433**  
跨接器; 从1到3; 绝缘; 浅灰色

[www.wago.com/2002-433](http://www.wago.com/2002-433)



**型号: 2002-434**  
跨接器; 从1到4; 绝缘; 浅灰色

[www.wago.com/2002-434](http://www.wago.com/2002-434)



**型号: 2002-435**  
跨接器; 从1到5; 绝缘; 浅灰色

[www.wago.com/2002-435](http://www.wago.com/2002-435)

**型号: 2002-436**

变更声明。 敬请关注进一步的产品说明文件！

WAGO Electronic (Tianjin) Co., Ltd.  
No.5, Quan Hui Road  
Wuqing Development Area | Tianjin 301700  
Tel.: +86 22 59677688 | Fax: +86 22 59617668  
Email: [info-cn@wago.com](mailto:info-cn@wago.com)

您有关于我们产品的任何问题吗？  
我们非常乐意接听您的来电， +86 (022) 59677688。

	跨接器; 从1到6; 绝缘; 浅灰色	<a href="http://www.wago.com/2002-436">www.wago.com/2002-436</a>
	<b>型号: 2002-437</b> 跨接器; 从1到7; 绝缘; 浅灰色	<a href="http://www.wago.com/2002-437">www.wago.com/2002-437</a>
	<b>型号: 2002-438</b> 跨接器; 从1到8; 绝缘; 浅灰色	<a href="http://www.wago.com/2002-438">www.wago.com/2002-438</a>
	<b>型号: 2002-439</b> 跨接器; 从1到9; 绝缘; 浅灰色	<a href="http://www.wago.com/2002-439">www.wago.com/2002-439</a>
	<b>型号: 2002-440</b> 跨接器; 从1到10; 绝缘; 浅灰色	<a href="http://www.wago.com/2002-440">www.wago.com/2002-440</a>
	<b>型号: 2002-472</b> 交错跨接器; 2插脚; 绝缘; 浅灰色	<a href="http://www.wago.com/2002-472">www.wago.com/2002-472</a>
	<b>型号: 2002-473</b> 交错跨接器; 3插脚; 绝缘; 浅灰色	<a href="http://www.wago.com/2002-473">www.wago.com/2002-473</a>
	<b>型号: 2002-473/011-000</b> 交错跨接器; 2插脚; 从1到3; 绝缘; 浅灰色	<a href="http://www.wago.com/2002-473/011-000">www.wago.com/2002-473/011-000</a>
	<b>型号: 2002-474</b> 交错跨接器; 4插脚; 绝缘; 浅灰色	<a href="http://www.wago.com/2002-474">www.wago.com/2002-474</a>
	<b>型号: 2002-475</b> 交错跨接器; 5插脚; 绝缘; 浅灰色	<a href="http://www.wago.com/2002-475">www.wago.com/2002-475</a>
	<b>型号: 2002-475/011-000</b> 交错跨接器; 3插脚; 绝缘; 浅灰色	<a href="http://www.wago.com/2002-475/011-000">www.wago.com/2002-475/011-000</a>
	<b>型号: 2002-476</b> 交错跨接器; 6插脚; 绝缘; 浅灰色	<a href="http://www.wago.com/2002-476">www.wago.com/2002-476</a>
	<b>型号: 2002-477</b> 交错跨接器; 7插脚; 绝缘; 浅灰色	<a href="http://www.wago.com/2002-477">www.wago.com/2002-477</a>
	<b>型号: 2002-477/011-000</b> 交错跨接器; 绝缘; 浅灰色	<a href="http://www.wago.com/2002-477/011-000">www.wago.com/2002-477/011-000</a>
	<b>型号: 2002-478</b> 交错跨接器; 8插脚; 绝缘; 浅灰色	<a href="http://www.wago.com/2002-478">www.wago.com/2002-478</a>
	<b>型号: 2002-479</b> 交错跨接器; 9插脚; 绝缘; 浅灰色	<a href="http://www.wago.com/2002-479">www.wago.com/2002-479</a>
	<b>型号: 2002-479/011-000</b> 交错跨接器; 绝缘; 浅灰色	<a href="http://www.wago.com/2002-479/011-000">www.wago.com/2002-479/011-000</a>

变更声明。 敬请关注进一步的产品说明文件！

WAGO Electronic (Tianjin) Co., Ltd.  
No.5, Quan Hui Road  
Wuqing Development Area | Tianjin 301700  
Tel.: +86 22 59677688 | Fax: +86 22 59617668  
Email: [info-cn@wago.com](mailto:info-cn@wago.com)

您有关于我们产品的任何问题吗？  
我们非常乐意接听您的来电， +86 (022) 59677688。

	<b>型号: 2002-480</b> 交错跨接器; 10插脚; 绝缘; 浅灰色	<a href="http://www.wago.com/2002-480">www.wago.com/2002-480</a>
	<b>型号: 2002-481</b> 交错跨接器; 11插脚; 绝缘; 浅灰色	<a href="http://www.wago.com/2002-481">www.wago.com/2002-481</a>
	<b>型号: 2002-481/011-000</b> 交错跨接器; 绝缘; 浅灰色	<a href="http://www.wago.com/2002-481/011-000">www.wago.com/2002-481/011-000</a>
	<b>型号: 2002-482</b> 交错跨接器; 12插脚; 绝缘; 浅灰色	<a href="http://www.wago.com/2002-482">www.wago.com/2002-482</a>
	<b>型号: 210-103</b> 导线型跨接器; 绝缘; 黑色	<a href="http://www.wago.com/210-103">www.wago.com/210-103</a>
	<b>型号: 210-123</b> 导线型跨接器; 绝缘; 蓝色	<a href="http://www.wago.com/210-123">www.wago.com/210-123</a>
<b>Protective Warning Marker</b>		
	<b>型号: 2002-115</b> 保护兼警告标志; 有高压符号, 黑色; 适于5个接线端子; 黄色	<a href="http://www.wago.com/2002-115">www.wago.com/2002-115</a>
<b>check</b>		
	<b>型号: 2002-511</b> 模块化TOPJOB@S连接器; 模块化; 适用于跨接器接点槽; 1极; 2,50 mm <sup>2</sup> ; 灰色	<a href="http://www.wago.com/2002-511">www.wago.com/2002-511</a>
	<b>型号: 2002-549</b> 间隔模块; 模块化; 例如, 用于间隔已跨接的接线端子; 灰色	<a href="http://www.wago.com/2002-549">www.wago.com/2002-549</a>
	<b>型号: 2002-552</b> 模块化TOPJOB@S连接器; 模块化; 适用于跨接器接点槽; 2极; 2,50 mm <sup>2</sup> ; 灰色	<a href="http://www.wago.com/2002-552">www.wago.com/2002-552</a>
	<b>型号: 2002-553</b> 模块化TOPJOB@S连接器; 模块化; 适用于跨接器接点槽; 3极; 2,50 mm <sup>2</sup> ; 灰色	<a href="http://www.wago.com/2002-553">www.wago.com/2002-553</a>
	<b>型号: 2002-554</b> 模块化TOPJOB@S连接器; 模块化; 适用于跨接器接点槽; 4极; 2,50 mm <sup>2</sup> ; 灰色	<a href="http://www.wago.com/2002-554">www.wago.com/2002-554</a>
	<b>型号: 2002-555</b> 模块化TOPJOB@S连接器; 模块化; 适用于跨接器接点槽; 5极; 2,50 mm <sup>2</sup> ; 灰色	<a href="http://www.wago.com/2002-555">www.wago.com/2002-555</a>
	<b>型号: 2002-556</b> 模块化TOPJOB@S连接器; 模块化; 适用于跨接器接点槽; 6极; 2,50 mm <sup>2</sup> ; 灰色	<a href="http://www.wago.com/2002-556">www.wago.com/2002-556</a>
	<b>型号: 2002-557</b> 模块化TOPJOB@S连接器; 模块化; 适用于跨接器接点槽; 7极; 2,50 mm <sup>2</sup> ; 灰色	<a href="http://www.wago.com/2002-557">www.wago.com/2002-557</a>
	<b>型号: 2002-558</b> 模块化TOPJOB@S连接器; 模块化; 适用于跨接器接点槽; 8极; 2,50 mm <sup>2</sup> ; 灰色	<a href="http://www.wago.com/2002-558">www.wago.com/2002-558</a>
	<b>型号: 2002-559</b> 模块化TOPJOB@S连接器; 模块化; 适用于跨接器接点槽; 9极; 2,50 mm <sup>2</sup> ; 灰色	<a href="http://www.wago.com/2002-559">www.wago.com/2002-559</a>

变更声明。敬请关注进一步的产品说明文件！

WAGO Electronic (Tianjin) Co., Ltd.  
No.5, Quan Hui Road  
Wuqing Development Area | Tianjin 301700  
Tel.: +86 22 59677688 | Fax: +86 22 59617668  
Email: info-cn@wago.com

您有关于我们产品的任何问题吗？  
我们非常乐意接听您的来电，+86 (022) 59677688。

	<b>型号: 2002-560</b> 模块化TOPJOB@S连接器; 模块化; 适用于跨接器接点槽; 10极; 2,50 mm <sup>2</sup> ; 灰色	<a href="http://www.wago.com/2002-560">www.wago.com/2002-560</a>
	<b>型号: 2002-611</b> TOPJOB@S L型测试插头模块; 模块化; 1极; 2,50 mm <sup>2</sup> ; 灰色	<a href="http://www.wago.com/2002-611">www.wago.com/2002-611</a>
	<b>型号: 2002-649</b> TOPJOB@S L型间隔模块; 模块化; 例如 , 用于间隔已跨接的接线端子; 灰色	<a href="http://www.wago.com/2002-649">www.wago.com/2002-649</a>
	<b>型号: 2009-174</b> 测试插头适配器; 适于测试插头4 mm Ø; 用于测试 TOPJOB@S 轨道式端子板; 灰色	<a href="http://www.wago.com/2009-174">www.wago.com/2009-174</a>
	<b>型号: 2009-182</b> 测试插头; 适用最大 2.5 mm <sup>2</sup> ; 可不使用任何工具与单根测试导线 ( 0.08 - 2.5 mm <sup>2</sup> ) 连接; 灰色	<a href="http://www.wago.com/2009-182">www.wago.com/2009-182</a>
	<b>型号: 210-136</b> 测试插头; 2 mm Ø; 带500 mm长电缆; 红色	<a href="http://www.wago.com/210-136">www.wago.com/210-136</a>

#### Marking accessories

	<b>型号: 2002-161</b> 适配器; 灰色	<a href="http://www.wago.com/2002-161">www.wago.com/2002-161</a>
	<b>型号: 2009-110</b> 标记条; 适于Smart Printer; 卷装; not stretchable; 空白; 卡装式; 白色	<a href="http://www.wago.com/2009-110">www.wago.com/2009-110</a>
	<b>型号: 2009-115</b> WMB-Inline; 适于Smart Printer; 每卷1500个标记; 5 - 5.2 mm可伸缩; 空白; 卡装式; 白色	<a href="http://www.wago.com/2009-115">www.wago.com/2009-115</a>
	<b>型号: 2009-115/000-002</b> WMB-Inline; 适于Smart Printer; 每卷1500个标记; 5 - 5.2 mm可伸缩; 空白; 卡装式; 黄色	<a href="http://www.wago.com/2009-115/000-002">www.wago.com/2009-115/000-002</a>
	<b>型号: 2009-115/000-006</b> WMB-Inline; 适于Smart Printer; 每卷1500个标记; 5 - 5.2 mm可伸缩; 空白; 卡装式; 蓝色	<a href="http://www.wago.com/2009-115/000-006">www.wago.com/2009-115/000-006</a>
	<b>型号: 2009-115/000-007</b> WMB-Inline; 适于Smart Printer; 每卷1500个标记; 5 - 5.2 mm可伸缩; 空白; 卡装式; 灰色	<a href="http://www.wago.com/2009-115/000-007">www.wago.com/2009-115/000-007</a>
	<b>型号: 2009-115/000-012</b> WMB-Inline; 适于Smart Printer; 每卷1500个标记; 5 - 5.2 mm可伸缩; 空白; 卡装式; 橙色	<a href="http://www.wago.com/2009-115/000-012">www.wago.com/2009-115/000-012</a>
	<b>型号: 2009-115/000-017</b> WMB-Inline; 适于Smart Printer; 每卷1500个标记; 5 - 5.2 mm可伸缩; 空白; 卡装式; 浅绿色	<a href="http://www.wago.com/2009-115/000-017">www.wago.com/2009-115/000-017</a>
	<b>型号: 2009-115/000-023</b> WMB-Inline; 适于Smart Printer; 每卷1500个标记; 5 - 5.2 mm可伸缩; 空白; 卡装式; 绿色	<a href="http://www.wago.com/2009-115/000-023">www.wago.com/2009-115/000-023</a>

变更声明。 敬请关注进一步的产品说明文件！

WAGO Electronic (Tianjin) Co., Ltd.  
No.5, Quan Hui Road  
Wuqing Development Area | Tianjin 301700  
Tel.: +86 22 59677688 | Fax: +86 22 59617668  
Email: [info-cn@wago.com](mailto:info-cn@wago.com)



您有关于我们产品的任何问题吗？  
我们非常乐意接听您的来电， +86 (022) 59677688。

•	<b>型号: 2009-115/000-024</b> WMB-Inline; 适于Smart Printer; 每卷1500个标记; 5 - 5.2 mm可伸缩; 空白; 卡装式; 紫色	<a href="http://www.wago.com/2009-115/000-024">www.wago.com/2009-115/000-024</a>
✓	<b>型号: 2009-145</b> Mini-WSB Inline; 适于Smart Printer; 每卷1700个标记; 5 - 5.2 mm可伸缩; 空白; 卡装式; 白色	<a href="http://www.wago.com/2009-145">www.wago.com/2009-145</a>
✓	<b>型号: 2009-145/000-002</b> Mini-WSB Inline; 适于Smart Printer; 每卷1700个标记; 5 - 5.2 mm可伸缩; 空白; 卡装式; 黄色	<a href="http://www.wago.com/2009-145/000-002">www.wago.com/2009-145/000-002</a>
✓	<b>型号: 2009-145/000-005</b> Mini-WSB Inline; 适于Smart Printer; 每卷1700个标记; 5 - 5.2 mm可伸缩; 空白; 卡装式; 红色	<a href="http://www.wago.com/2009-145/000-005">www.wago.com/2009-145/000-005</a>
✓	<b>型号: 2009-145/000-006</b> Mini-WSB Inline; 适于Smart Printer; 每卷1700个标记; 5 - 5.2 mm可伸缩; 空白; 卡装式; 蓝色	<a href="http://www.wago.com/2009-145/000-006">www.wago.com/2009-145/000-006</a>
✓	<b>型号: 2009-145/000-007</b> Mini-WSB Inline; 适于Smart Printer; 每卷1700个标记; 5 - 5.2 mm可伸缩; 空白; 卡装式; 灰色	<a href="http://www.wago.com/2009-145/000-007">www.wago.com/2009-145/000-007</a>
✓	<b>型号: 2009-145/000-012</b> Mini-WSB Inline; 适于Smart Printer; 每卷1700个标记; 5 - 5.2 mm可伸缩; 空白; 卡装式; 橙色	<a href="http://www.wago.com/2009-145/000-012">www.wago.com/2009-145/000-012</a>
✓	<b>型号: 2009-145/000-023</b> Mini-WSB Inline; 适于Smart Printer; 每卷1700个标记; 5 - 5.2 mm可伸缩; 空白; 卡装式; 绿色	<a href="http://www.wago.com/2009-145/000-023">www.wago.com/2009-145/000-023</a>
✓	<b>型号: 2009-145/000-024</b> Mini-WSB Inline; 适于Smart Printer; 每卷1700个标记; 5 - 5.2 mm可伸缩; 空白; 卡装式; 紫色	<a href="http://www.wago.com/2009-145/000-024">www.wago.com/2009-145/000-024</a>
	<b>型号: 2009-191</b> 组标记支架	<a href="http://www.wago.com/2009-191">www.wago.com/2009-191</a>
	<b>型号: 2009-192</b> 组标记支架	<a href="http://www.wago.com/2009-192">www.wago.com/2009-192</a>
	<b>型号: 2009-193</b> 组标记支架	<a href="http://www.wago.com/2009-193">www.wago.com/2009-193</a>
	<b>型号: 2009-198</b> 适配器; 灰色	<a href="http://www.wago.com/2009-198">www.wago.com/2009-198</a>
	<b>型号: 248-501</b> Mini-WSB标记牌; 详见卡片; not stretchable; 空白; 卡装式; 白色	<a href="http://www.wago.com/248-501">www.wago.com/248-501</a>
	<b>型号: 248-501/000-002</b> Mini-WSB标记牌; 详见卡片; not stretchable; 空白; 卡装式; 黄色	<a href="http://www.wago.com/248-501/000-002">www.wago.com/248-501/000-002</a>

变更声明。敬请关注进一步的产品说明文件！

WAGO Electronic (Tianjin) Co., Ltd.  
No.5, Quan Hui Road  
Wuqing Development Area | Tianjin 301700  
Tel.: +86 22 59677688 | Fax: +86 22 59617668  
Email: [info-cn@wago.com](mailto:info-cn@wago.com)

您有关于我们产品的任何问题吗？  
我们非常乐意接听您的来电， +86 (022) 59677688。

	<b>型号: 248-501/000-005</b> Mini-WSB标记牌; 详见卡片; not stretchable; 空白; 卡装式; 红色	<a href="http://www.wago.com/248-501/000-005">www.wago.com/248-501/000-005</a>
	<b>型号: 248-501/000-006</b> Mini-WSB标记牌; 详见卡片; not stretchable; 空白; 卡装式; 蓝色	<a href="http://www.wago.com/248-501/000-006">www.wago.com/248-501/000-006</a>
	<b>型号: 248-501/000-007</b> Mini-WSB标记牌; 详见卡片; not stretchable; 空白; 卡装式; 灰色	<a href="http://www.wago.com/248-501/000-007">www.wago.com/248-501/000-007</a>
	<b>型号: 248-501/000-012</b> Mini-WSB标记牌; 详见卡片; not stretchable; 空白; 卡装式; 橙色	<a href="http://www.wago.com/248-501/000-012">www.wago.com/248-501/000-012</a>
	<b>型号: 248-501/000-017</b> Mini-WSB标记牌; 详见卡片; not stretchable; 空白; 卡装式; 浅绿色	<a href="http://www.wago.com/248-501/000-017">www.wago.com/248-501/000-017</a>
	<b>型号: 248-501/000-023</b> Mini-WSB标记牌; 详见卡片; not stretchable; 空白; 卡装式; 绿色	<a href="http://www.wago.com/248-501/000-023">www.wago.com/248-501/000-023</a>
	<b>型号: 248-501/000-024</b> Mini-WSB标记牌; 详见卡片; not stretchable; 空白; 卡装式; 紫色	<a href="http://www.wago.com/248-501/000-024">www.wago.com/248-501/000-024</a>
	<b>型号: 793-501</b> WMB标记卡; 详见卡片; not stretchable; 空白; 卡装式; 白色	<a href="http://www.wago.com/793-501">www.wago.com/793-501</a>
	<b>型号: 793-501/000-002</b> WMB标记卡; 详见卡片; not stretchable; 空白; 卡装式; 黄色	<a href="http://www.wago.com/793-501/000-002">www.wago.com/793-501/000-002</a>
	<b>型号: 793-501/000-005</b> WMB标记卡; 详见卡片; not stretchable; 空白; 卡装式; 红色	<a href="http://www.wago.com/793-501/000-005">www.wago.com/793-501/000-005</a>
	<b>型号: 793-501/000-006</b> WMB标记卡; 详见卡片; not stretchable; 空白; 卡装式; 蓝色	<a href="http://www.wago.com/793-501/000-006">www.wago.com/793-501/000-006</a>
	<b>型号: 793-501/000-007</b> WMB标记卡; 详见卡片; not stretchable; 空白; 卡装式; 灰色	<a href="http://www.wago.com/793-501/000-007">www.wago.com/793-501/000-007</a>
	<b>型号: 793-501/000-012</b> WMB标记卡; 详见卡片; not stretchable; 空白; 卡装式; 橙色	<a href="http://www.wago.com/793-501/000-012">www.wago.com/793-501/000-012</a>
	<b>型号: 793-501/000-017</b> WMB标记卡; 详见卡片; not stretchable; 空白; 卡装式; 浅绿色	<a href="http://www.wago.com/793-501/000-017">www.wago.com/793-501/000-017</a>

变更声明。 敬请关注进一步的产品说明文件！

WAGO Electronic (Tianjin) Co., Ltd.  
No.5, Quan Hui Road  
Wuqing Development Area | Tianjin 301700  
Tel.: +86 22 59677688 | Fax: +86 22 59617668  
Email: [info-cn@wago.com](mailto:info-cn@wago.com)

您有关于我们产品的任何问题吗？  
我们非常乐意接听您的来电， +86 (022) 59677688。

	<b>型号: 793-501/000-023</b> WMB标记卡; 详见卡片; not stretchable; 空白; 卡装式; 绿色	<a href="http://www.wago.com/793-501/000-023">www.wago.com/793-501/000-023</a>
	<b>型号: 793-501/000-024</b> WMB标记卡; 详见卡片; not stretchable; 空白; 卡装式; 紫色	<a href="http://www.wago.com/793-501/000-024">www.wago.com/793-501/000-024</a>
	<b>型号: 793-5501</b> WMB标记卡; 详见卡片; 用于接线端子厚度 5 - 17.5 mm; 5 - 5.2 mm可伸缩; 空白; 卡装式; 白色	<a href="http://www.wago.com/793-5501">www.wago.com/793-5501</a>
	<b>型号: 793-5501/000-002</b> WMB标记卡; 详见卡片; 用于接线端子厚度 5 - 17.5 mm; 5 - 5.2 mm可伸缩; 空白; 卡装式; 黄色	<a href="http://www.wago.com/793-5501/000-002">www.wago.com/793-5501/000-002</a>
	<b>型号: 793-5501/000-005</b> WMB标记卡; 详见卡片; 用于接线端子厚度 5 - 17.5 mm; 5 - 5.2 mm可伸缩; 空白; 卡装式; 红色	<a href="http://www.wago.com/793-5501/000-005">www.wago.com/793-5501/000-005</a>
	<b>型号: 793-5501/000-006</b> WMB标记卡; 详见卡片; 用于接线端子厚度 5 - 17.5 mm; 5 - 5.2 mm可伸缩; 空白; 卡装式; 蓝色	<a href="http://www.wago.com/793-5501/000-006">www.wago.com/793-5501/000-006</a>
	<b>型号: 793-5501/000-007</b> WMB标记卡; 详见卡片; 用于接线端子厚度 5 - 17.5 mm; 5 - 5.2 mm可伸缩; 空白; 卡装式; 灰色	<a href="http://www.wago.com/793-5501/000-007">www.wago.com/793-5501/000-007</a>
	<b>型号: 793-5501/000-012</b> WMB标记卡; 详见卡片; 用于接线端子厚度 5 - 17.5 mm; 5 - 5.2 mm可伸缩; 空白; 卡装式; 橙色	<a href="http://www.wago.com/793-5501/000-012">www.wago.com/793-5501/000-012</a>
	<b>型号: 793-5501/000-017</b> WMB标记卡; 详见卡片; 用于接线端子厚度 5 - 17.5 mm; 5 - 5.2 mm可伸缩; 空白; 卡装式; 绿色	<a href="http://www.wago.com/793-5501/000-017">www.wago.com/793-5501/000-017</a>
	<b>型号: 793-5501/000-023</b> WMB标记卡; 详见卡片; 用于接线端子厚度 5 - 17.5 mm; 5 - 5.2 mm可伸缩; 空白; 卡装式; 浅绿色	<a href="http://www.wago.com/793-5501/000-023">www.wago.com/793-5501/000-023</a>
	<b>型号: 793-5501/000-024</b> WMB标记卡; 详见卡片; 用于接线端子厚度 5 - 17.5 mm; 5 - 5.2 mm可伸缩; 空白; 卡装式; 紫色	<a href="http://www.wago.com/793-5501/000-024">www.wago.com/793-5501/000-024</a>
<b>tools</b>		
	<b>型号: 210-658</b> 操作工具; 刀口尺寸 : 3.5 x 0.5 mm; 带有绝缘手柄; 弯角; 短; 多种颜色	<a href="http://www.wago.com/210-658">www.wago.com/210-658</a>
	<b>型号: 210-720</b> 操作工具; 刀口尺寸 : 3.5 x 0.5 mm; 带有绝缘手柄; 多种颜色	<a href="http://www.wago.com/210-720">www.wago.com/210-720</a>

变更声明。 敬请关注进一步的产品说明文件！

WAGO Electronic (Tianjin) Co., Ltd.  
No.5, Quan Hui Road  
Wuqing Development Area | Tianjin 301700  
Tel.: +86 22 59677688 | Fax: +86 22 59617668  
Email: info-cn@wago.com

您有关于我们产品的任何问题吗？  
我们非常乐意接听您的来电， +86 (022) 59677688。



**下载  
文档**

**Bid Text**

2102-1301 X81 - Datei	2019年5月15日	xml 4.1 kB	下载
--------------------------	------------	---------------	----

2102-1301 docx - Datei	2019年5月14日	docx 15.1 kB	下载
---------------------------	------------	-----------------	----

**Additional Information**

Technical explanations	2019年4月3日	pdf 2.2 MB	下载
------------------------	-----------	---------------	----

**CAD/CAE-Data**

**CAD data**

2D/3D Models 2102-1301		URL	下载
------------------------	--	-----	----

**CAE data**

EPLAN Data Portal 2102-1301		URL	下载
-----------------------------	--	-----	----

ZUKEN Portal 2102-1301		URL	下载
------------------------	--	-----	----

**Environmental Product Compliance**

**Compliance Search**

Environmental Product Compliance 2102-1301		URL	下载
--	--	-----	----

3线普通接线端子; 具有操作手柄及直插型笼式弹簧接线单元; 2.5 mm<sup>2</sup>; 有测试插孔; 侧面/中心标记; 适于35 x 15 和 35 x 7.5导轨; Push-in CAGE CLAMP®; 2,50 mm<sup>2</sup>; 灰色

**Installation Notes**

**连接导线**

变更声明。 敬请关注进一步的产品说明文件！

WAGO Electronic (Tianjin) Co., Ltd.  
No.5, Quan Hui Road  
Wuqing Development Area | Tianjin 301700  
Tel.: +86 22 59677688 | Fax: +86 22 59617668  
Email: info-cn@wago.com

您有关于我们产品的任何问题吗？  
我们非常乐意接听您的来电， +86 (022) 59677688。



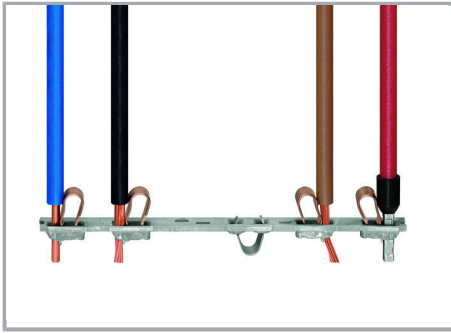

All conductor types at a glance

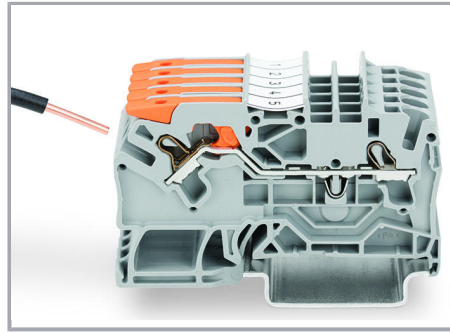

Push-in termination of solid conductors

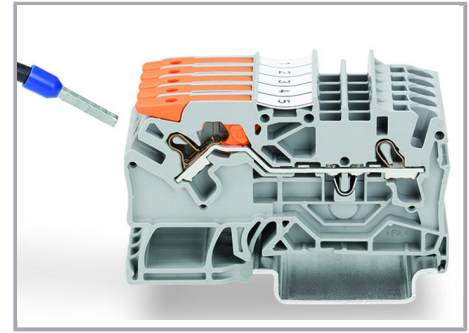

Push-in termination of fine-stranded conductors with ferrules

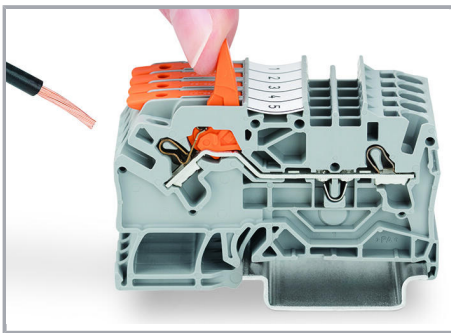

Pull the lever up until it stops, then connect the fine-stranded conductor.

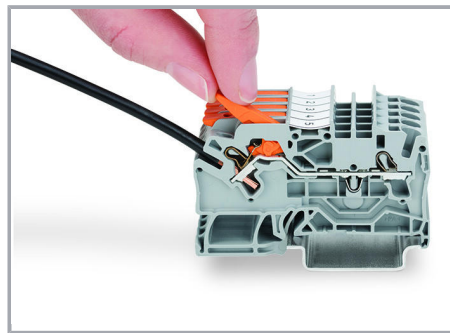

Push the lever back down – done!

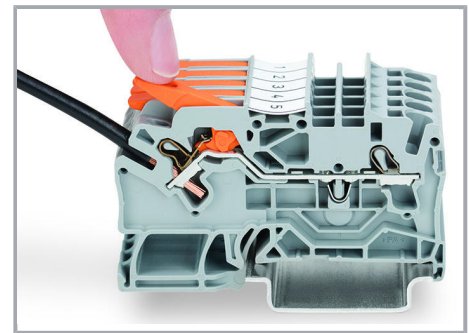

Push the lever back down – done!

### 跨接

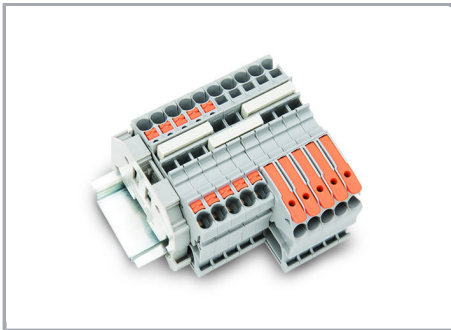

Insert a push-in type jumper bar and push down until it hits the backstop.

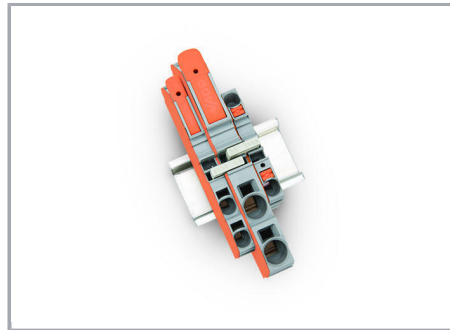

Commoning with step-down jumpers.

### 测试

变更声明。 敬请关注进一步的产品说明文件！

WAGO Electronic (Tianjin) Co., Ltd.  
No.5, Quan Hui Road  
Wuqing Development Area | Tianjin 301700  
Tel.: +86 22 59677688 | Fax: +86 22 59617668  
Email: [info-cn@wago.com](mailto:info-cn@wago.com)

您有关于我们产品的任何问题吗？  
我们非常乐意接听您的来电， +86 (022) 59677688。

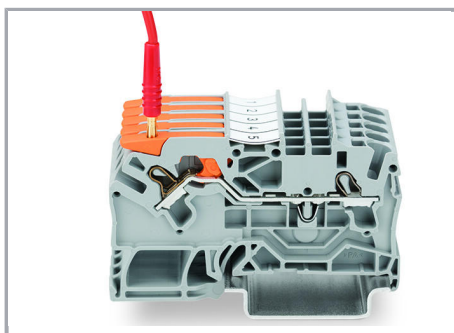

Testing with a 2 mm Ø test plug (max. 42 V).

### 标记

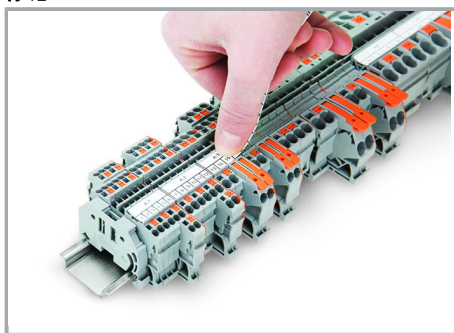

Snapping a marking strip into a marker slot.

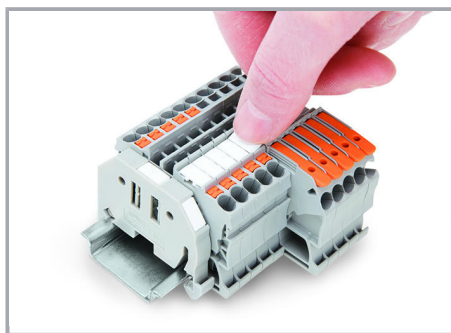

Snapping a marking strip into the marker slot.

### 产品系列

#### TOPJOB® S

TOPJOB® S: In various industrial applications and modern building installations, WAGO's wide and versatile range of rail-mount terminal blocks provides more than just reliable electrical connections.

[显示该系列的所有产品。](#)

变更声明。 敬请关注进一步的产品说明文件！

WAGO Electronic (Tianjin) Co., Ltd.  
No.5, Quan Hui Road  
Wuqing Development Area | Tianjin 301700  
Tel.: +86 22 59677688 | Fax: +86 22 59617668  
Email: [info-cn@wago.com](mailto:info-cn@wago.com)

您有关于我们产品的任何问题吗？  
我们非常乐意接听您的来电， +86 (022) 59677688。