

## 规格书 | 型号: 2003-7641

多层电气安装用接线端子; 带有操作孔; 2.5 mm<sup>2</sup>; 带有N线可分断滑块; NT/L/PE;  
Push-in CAGE CLAMP®; 2,50 mm<sup>2</sup>; 灰色

[www.wago.com/2003-7641](http://www.wago.com/2003-7641)

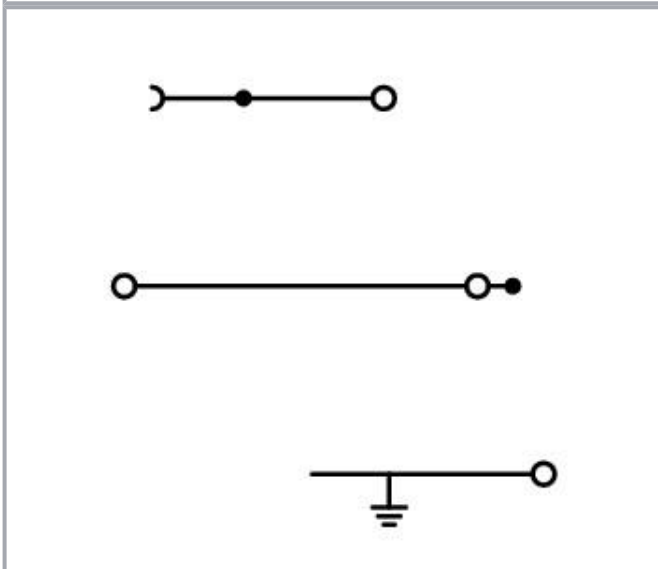
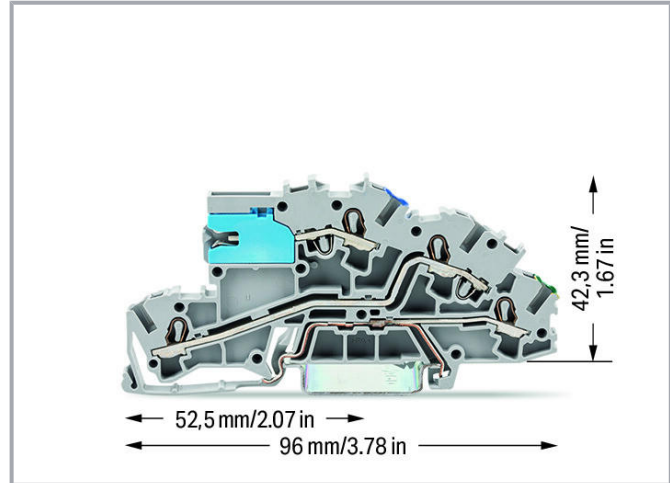
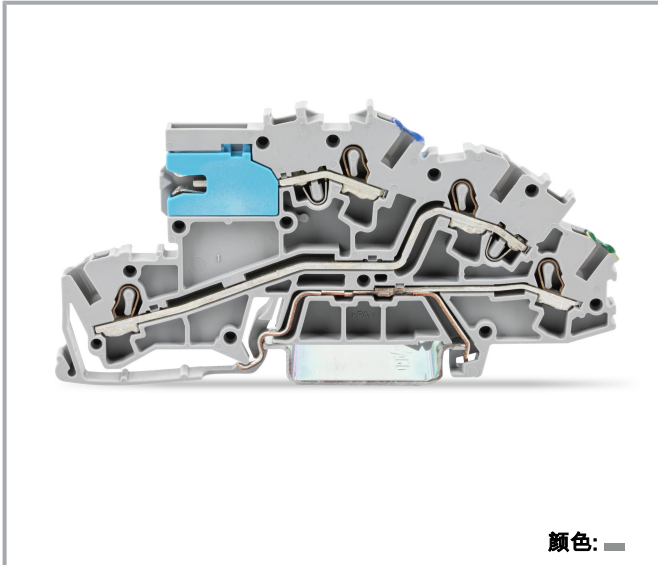

## 数据 电气参数

变更声明。 敬请关注进一步的产品说明文件！

WAGO Electronic (Tianjin) Co., Ltd.  
No.5, Quan Hui Road  
Wuqing Development Area | Tianjin 301700  
Tel.: +86 22 59677688 | Fax: +86 22 59617668  
Email: info-cn@wago.com

您有关于我们产品的任何问题吗？  
我们非常乐意接听您的来电， +86 (022) 59677688。

## Ratings per IEC/EN

额定电气参数(注)	电位对地
额定电压(III/3)	250 V
额定浪涌电压(III/3)	4 kV
额定电流	24 A
额定电气参数(注) 2	电位间
额定电压(III/3) 2	400 V
额定浪涌电压(III/3) 2	6 kV
额定电流2	32 A
图例(额定电气参数)	(III / 3) △ 过电压类别III/污染等级3

## 接线参数

连接技术	直插型笼式弹簧接线单元(Push-in CAGE CLAMP®)
执行类型	推入式 操作工具
可连接导线材料	铜
额定导线截面积	2.5 mm <sup>2</sup>
单股导线	0.25 ... 4 mm <sup>2</sup> / 22 ... 12 AWG
单股导线；可直接插入	0.75 ... 4 mm <sup>2</sup> / 18 ... 12 AWG
细多股导线	0.25 ... 4 mm <sup>2</sup> / 22 ... 12 AWG
细多股导线；加有带绝缘护套的冷压接头	0.25 ... 2.5 mm <sup>2</sup> / 22 ... 14 AWG
细多股导线；加有冷压接头；可直接插入	1 ... 2.5 mm <sup>2</sup> / 18 ... 14 AWG
说明(导线截面积)	横截面较小的导线也可以直接插入,具体取决于导线特性。
剥线长度	10 ... 12 mm / 0.39 ... 0.47 英寸
连接点总数	5
电位总数量	3
层数	3
接线类型	正面接线

## Geometrical Data

宽度	5.2 mm / 0.205 inch
高度	96 mm / 3.78 inch
以DIN导轨的上边线为基准的深度	42.3 mm / 1.665 inch

变更声明。 敬请关注进一步的产品说明文件！

WAGO Electronic (Tianjin) Co., Ltd.  
No.5, Quan Hui Road  
Wuqing Development Area | Tianjin 301700  
Tel.: +86 22 59677688 | Fax: +86 22 59617668  
Email: info-cn@wago.com

您有关于我们产品的任何问题吗？  
我们非常乐意接听您的来电， +86 (022) 59677688。

## 机械参数

电位标记	NT/L/PE
设计	弯角型
安装方式	DIN-35型导轨
标记位	中央/侧面标记位

## 材料参数

颜色	灰色
绝缘材料	尼龙66 (PA 66)
火灾荷载	0.247 MJ
重量	16.7 g

## 商业数据

Product Group	22 (TOPJOB S)
包装类型	BOX
原产国	DE
GTIN	4044918925587
海关税号	85369010000

## 认证 / 证书

### 船级社认证

标识	认证	其他认证信息	认证名称
	CCA DEKRA Certification B.V.	EN 60947	NTR NL- 7828
	CCA DEKRA Certification B.V.	EN 60947	71- 113530



### 船级社认证

标识	认证	其他认证信息	认证名称
	ABS American Bureau of Shipping	EN 60947	20- HG1941090- PDA

变更声明。敬请关注进一步的产品说明文件！

WAGO Electronic (Tianjin) Co., Ltd.  
No.5, Quan Hui Road  
Wuqing Development Area | Tianjin 301700  
Tel.: +86 22 59677688 | Fax: +86 22 59617668  
Email: info-cn@wago.com

您有关于我们产品的任何问题吗？  
我们非常乐意接听您的来电，+86 (022) 59677688。

	<b>DNV GL</b> Det Norske Veritas, Germanischer Lloyd	-	TAE00001V2
	<b>LR</b> Lloyds Register	EN 60947	91/20112 (E9)

## 所需附件

### End plate

	<b>型号: 2003-7692</b> 端板和隔板; 厚度 0.8 mm; 橙色	<a href="http://www.wago.com/2003-7692">www.wago.com/2003-7692</a>
---	--	--

## 适用产品

### Marking accessories

*	<b>型号: 2009-110</b> 标记条; 适于Smart Printer; 卷装; not stretchable; 空白; 卡装式; 白色	<a href="http://www.wago.com/2009-110">www.wago.com/2009-110</a>
*	<b>型号: 2009-115</b> WMB-Inline; 适于Smart Printer; 每卷1500个标记; 5 - 5.2 mm可伸缩; 空白; 卡装式; 白色	<a href="http://www.wago.com/2009-115">www.wago.com/2009-115</a>
*	<b>型号: 2009-115/000-002</b> WMB-Inline; 适于Smart Printer; 每卷1500个标记; 5 - 5.2 mm可伸缩; 空白; 卡装式; 黄色	<a href="http://www.wago.com/2009-115/000-002">www.wago.com/2009-115/000-002</a>
*	<b>型号: 2009-115/000-005</b> WMB-Inline; 适于Smart Printer; 每卷1500个标记; 5 - 5.2 mm可伸缩; 空白; 卡装式; 红色	<a href="http://www.wago.com/2009-115/000-005">www.wago.com/2009-115/000-005</a>
*	<b>型号: 2009-115/000-006</b> WMB-Inline; 适于Smart Printer; 每卷1500个标记; 5 - 5.2 mm可伸缩; 空白; 卡装式; 蓝色	<a href="http://www.wago.com/2009-115/000-006">www.wago.com/2009-115/000-006</a>
*	<b>型号: 2009-115/000-007</b> WMB-Inline; 适于Smart Printer; 每卷1500个标记; 5 - 5.2 mm可伸缩; 空白; 卡装式; 灰色	<a href="http://www.wago.com/2009-115/000-007">www.wago.com/2009-115/000-007</a>
*	<b>型号: 2009-115/000-012</b> WMB-Inline; 适于Smart Printer; 每卷1500个标记; 5 - 5.2 mm可伸缩; 空白; 卡装式; 橙色	<a href="http://www.wago.com/2009-115/000-012">www.wago.com/2009-115/000-012</a>
*	<b>型号: 2009-115/000-017</b> WMB-Inline; 适于Smart Printer; 每卷1500个标记; 5 - 5.2 mm可伸缩; 空白; 卡装式; 浅绿色	<a href="http://www.wago.com/2009-115/000-017">www.wago.com/2009-115/000-017</a>

变更声明。敬请关注进一步的产品说明文件！

WAGO Electronic (Tianjin) Co., Ltd.  
 No.5, Quan Hui Road  
 Wuqing Development Area | Tianjin 301700  
 Tel.: +86 22 59677688 | Fax: +86 22 59617668  
 Email: info-cn@wago.com







您有关于我们产品的任何问题吗？  
 我们非常乐意接听您的来电，+86 (022) 59677688。

	<b>型号: 2009-115/000-023</b> WMB-Inline; 适于Smart Printer; 每卷1500个标记; 5 - 5.2 mm可伸缩; 空白; 卡装式; 绿色	<a href="http://www.wago.com/2009-115/000-023">www.wago.com/2009-115/000-023</a>
	<b>型号: 2009-115/000-024</b> WMB-Inline; 适于Smart Printer; 每卷1500个标记; 5 - 5.2 mm可伸缩; 空白; 卡装式; 紫色	<a href="http://www.wago.com/2009-115/000-024">www.wago.com/2009-115/000-024</a>
	<b>型号: 2009-145</b> Mini-WSB Inline; 适于Smart Printer; 每卷1700个标记; 5 - 5.2 mm可伸缩; 空白; 卡装式; 白色	<a href="http://www.wago.com/2009-145">www.wago.com/2009-145</a>
	<b>型号: 2009-145/000-002</b> Mini-WSB Inline; 适于Smart Printer; 每卷1700个标记; 5 - 5.2 mm可伸缩; 空白; 卡装式; 黄色	<a href="http://www.wago.com/2009-145/000-002">www.wago.com/2009-145/000-002</a>
	<b>型号: 2009-145/000-005</b> Mini-WSB Inline; 适于Smart Printer; 每卷1700个标记; 5 - 5.2 mm可伸缩; 空白; 卡装式; 红色	<a href="http://www.wago.com/2009-145/000-005">www.wago.com/2009-145/000-005</a>
	<b>型号: 2009-145/000-006</b> Mini-WSB Inline; 适于Smart Printer; 每卷1700个标记; 5 - 5.2 mm可伸缩; 空白; 卡装式; 蓝色	<a href="http://www.wago.com/2009-145/000-006">www.wago.com/2009-145/000-006</a>
	<b>型号: 2009-145/000-007</b> Mini-WSB Inline; 适于Smart Printer; 每卷1700个标记; 5 - 5.2 mm可伸缩; 空白; 卡装式; 灰色	<a href="http://www.wago.com/2009-145/000-007">www.wago.com/2009-145/000-007</a>
	<b>型号: 2009-145/000-012</b> Mini-WSB Inline; 适于Smart Printer; 每卷1700个标记; 5 - 5.2 mm可伸缩; 空白; 卡装式; 橙色	<a href="http://www.wago.com/2009-145/000-012">www.wago.com/2009-145/000-012</a>
	<b>型号: 2009-145/000-023</b> Mini-WSB Inline; 适于Smart Printer; 每卷1700个标记; 5 - 5.2 mm可伸缩; 空白; 卡装式; 绿色	<a href="http://www.wago.com/2009-145/000-023">www.wago.com/2009-145/000-023</a>
	<b>型号: 2009-145/000-024</b> Mini-WSB Inline; 适于Smart Printer; 每卷1700个标记; 5 - 5.2 mm可伸缩; 空白; 卡装式; 紫色	<a href="http://www.wago.com/2009-145/000-024">www.wago.com/2009-145/000-024</a>
	<b>型号: 2009-191</b> 组标记支架	<a href="http://www.wago.com/2009-191">www.wago.com/2009-191</a>
	<b>型号: 2009-192</b> 组标记支架	<a href="http://www.wago.com/2009-192">www.wago.com/2009-192</a>
	<b>型号: 2009-193</b> 组标记支架	<a href="http://www.wago.com/2009-193">www.wago.com/2009-193</a>
	<b>型号: 2009-198</b> 适配器; 灰色	<a href="http://www.wago.com/2009-198">www.wago.com/2009-198</a>
	<b>型号: 248-501</b> Mini-WSB标记牌; 详见卡片; not stretchable; 空白; 卡装式; 白色	<a href="http://www.wago.com/248-501">www.wago.com/248-501</a>

变更声明。敬请关注进一步的产品说明文件！

WAGO Electronic (Tianjin) Co., Ltd.  
No.5, Quan Hui Road  
Wuqing Development Area | Tianjin 301700  
Tel.: +86 22 59677688 | Fax: +86 22 59617668  
Email: [info-cn@wago.com](mailto:info-cn@wago.com)

您有关于我们产品的任何问题吗？  
我们非常乐意接听您的来电， +86 (022) 59677688。

	<b>型号: 248-501/000-002</b> Mini-WSB标记牌; 详见卡片; not stretchable; 空白; 卡装式; 黄色	<a href="http://www.wago.com/248-501/000-002">www.wago.com/248-501/000-002</a>
	<b>型号: 248-501/000-005</b> Mini-WSB标记牌; 详见卡片; not stretchable; 空白; 卡装式; 红色	<a href="http://www.wago.com/248-501/000-005">www.wago.com/248-501/000-005</a>
	<b>型号: 248-501/000-006</b> Mini-WSB标记牌; 详见卡片; not stretchable; 空白; 卡装式; 蓝色	<a href="http://www.wago.com/248-501/000-006">www.wago.com/248-501/000-006</a>
	<b>型号: 248-501/000-007</b> Mini-WSB标记牌; 详见卡片; not stretchable; 空白; 卡装式; 灰色	<a href="http://www.wago.com/248-501/000-007">www.wago.com/248-501/000-007</a>
	<b>型号: 248-501/000-012</b> Mini-WSB标记牌; 详见卡片; not stretchable; 空白; 卡装式; 橙色	<a href="http://www.wago.com/248-501/000-012">www.wago.com/248-501/000-012</a>
	<b>型号: 248-501/000-017</b> Mini-WSB标记牌; 详见卡片; not stretchable; 空白; 卡装式; 浅绿色	<a href="http://www.wago.com/248-501/000-017">www.wago.com/248-501/000-017</a>
	<b>型号: 248-501/000-023</b> Mini-WSB标记牌; 详见卡片; not stretchable; 空白; 卡装式; 绿色	<a href="http://www.wago.com/248-501/000-023">www.wago.com/248-501/000-023</a>
	<b>型号: 248-501/000-024</b> Mini-WSB标记牌; 详见卡片; not stretchable; 空白; 卡装式; 紫色	<a href="http://www.wago.com/248-501/000-024">www.wago.com/248-501/000-024</a>
	<b>型号: 793-501</b> WMB标记卡; 详见卡片; not stretchable; 空白; 卡装式; 白色	<a href="http://www.wago.com/793-501">www.wago.com/793-501</a>
	<b>型号: 793-501/000-002</b> WMB标记卡; 详见卡片; not stretchable; 空白; 卡装式; 黄色	<a href="http://www.wago.com/793-501/000-002">www.wago.com/793-501/000-002</a>
	<b>型号: 793-501/000-005</b> WMB标记卡; 详见卡片; not stretchable; 空白; 卡装式; 红色	<a href="http://www.wago.com/793-501/000-005">www.wago.com/793-501/000-005</a>
	<b>型号: 793-501/000-006</b> WMB标记卡; 详见卡片; not stretchable; 空白; 卡装式; 蓝色	<a href="http://www.wago.com/793-501/000-006">www.wago.com/793-501/000-006</a>
	<b>型号: 793-501/000-007</b> WMB标记卡; 详见卡片; not stretchable; 空白; 卡装式; 灰色	<a href="http://www.wago.com/793-501/000-007">www.wago.com/793-501/000-007</a>
	<b>型号: 793-501/000-012</b> WMB标记卡; 详见卡片; not stretchable; 空白; 卡装式; 橙色	<a href="http://www.wago.com/793-501/000-012">www.wago.com/793-501/000-012</a>

变更声明。敬请关注进一步的产品说明文件！

WAGO Electronic (Tianjin) Co., Ltd.  
No.5, Quan Hui Road  
Wuqing Development Area | Tianjin 301700  
Tel.: +86 22 59677688 | Fax: +86 22 59617668  
Email: info-cn@wago.com

您有关于我们产品的任何问题吗？  
我们非常乐意接听您的来电， +86 (022) 59677688。

	<b>型号: 793-501/000-017</b> WMB标记卡; 详见卡片; not stretchable; 空白; 卡装式; 浅绿色	<a href="http://www.wago.com/793-501/000-017">www.wago.com/793-501/000-017</a>
	<b>型号: 793-501/000-023</b> WMB标记卡; 详见卡片; not stretchable; 空白; 卡装式; 绿色	<a href="http://www.wago.com/793-501/000-023">www.wago.com/793-501/000-023</a>
	<b>型号: 793-501/000-024</b> WMB标记卡; 详见卡片; not stretchable; 空白; 卡装式; 紫色	<a href="http://www.wago.com/793-501/000-024">www.wago.com/793-501/000-024</a>
	<b>型号: 793-5501</b> WMB标记卡; 详见卡片; 用于接线端子厚度 5 - 17.5 mm; 5 - 5.2 mm可伸缩; 空白; 卡装式; 白色	<a href="http://www.wago.com/793-5501">www.wago.com/793-5501</a>
	<b>型号: 793-5501/000-002</b> WMB标记卡; 详见卡片; 用于接线端子厚度 5 - 17.5 mm; 5 - 5.2 mm可伸缩; 空白; 卡装式; 黄色	<a href="http://www.wago.com/793-5501/000-002">www.wago.com/793-5501/000-002</a>
	<b>型号: 793-5501/000-005</b> WMB标记卡; 详见卡片; 用于接线端子厚度 5 - 17.5 mm; 5 - 5.2 mm可伸缩; 空白; 卡装式; 红色	<a href="http://www.wago.com/793-5501/000-005">www.wago.com/793-5501/000-005</a>
	<b>型号: 793-5501/000-006</b> WMB标记卡; 详见卡片; 用于接线端子厚度 5 - 17.5 mm; 5 - 5.2 mm可伸缩; 空白; 卡装式; 蓝色	<a href="http://www.wago.com/793-5501/000-006">www.wago.com/793-5501/000-006</a>
	<b>型号: 793-5501/000-007</b> WMB标记卡; 详见卡片; 用于接线端子厚度 5 - 17.5 mm; 5 - 5.2 mm可伸缩; 空白; 卡装式; 灰色	<a href="http://www.wago.com/793-5501/000-007">www.wago.com/793-5501/000-007</a>
	<b>型号: 793-5501/000-012</b> WMB标记卡; 详见卡片; 用于接线端子厚度 5 - 17.5 mm; 5 - 5.2 mm可伸缩; 空白; 卡装式; 橙色	<a href="http://www.wago.com/793-5501/000-012">www.wago.com/793-5501/000-012</a>
	<b>型号: 793-5501/000-014</b> WMB标记卡; 详见卡片; 用于接线端子厚度 5 - 17.5 mm; 5 - 5.2 mm可伸缩; 空白; 卡装式; 棕色	<a href="http://www.wago.com/793-5501/000-014">www.wago.com/793-5501/000-014</a>
	<b>型号: 793-5501/000-017</b> WMB标记卡; 详见卡片; 用于接线端子厚度 5 - 17.5 mm; 5 - 5.2 mm可伸缩; 空白; 卡装式; 绿色	<a href="http://www.wago.com/793-5501/000-017">www.wago.com/793-5501/000-017</a>
	<b>型号: 793-5501/000-023</b> WMB标记卡; 详见卡片; 用于接线端子厚度 5 - 17.5 mm; 5 - 5.2 mm可伸缩; 空白; 卡装式; 浅绿色	<a href="http://www.wago.com/793-5501/000-023">www.wago.com/793-5501/000-023</a>
	<b>型号: 793-5501/000-024</b> WMB标记卡; 详见卡片; 用于接线端子厚度 5 - 17.5 mm; 5 - 5.2 mm可伸缩; 空白; 卡装式; 紫色	<a href="http://www.wago.com/793-5501/000-024">www.wago.com/793-5501/000-024</a>

#### Insulation stop

**型号: 2002-171**

变更声明。 敬请关注进一步的产品说明文件！

WAGO Electronic (Tianjin) Co., Ltd.  
No.5, Quan Hui Road  
Wuqing Development Area | Tianjin 301700  
Tel.: +86 22 59677688 | Fax: +86 22 59617668  
Email: [info-cn@wago.com](mailto:info-cn@wago.com)

您有关于我们产品的任何问题吗？  
我们非常乐意接听您的来电， +86 (022) 59677688。

	绝缘挡块; 0.25 - 0.5 mm <sup>2</sup> ; 5件/条; 浅灰色	<a href="http://www.wago.com/2002-171">www.wago.com/2002-171</a>
	<b>型号: 2002-172</b> 绝缘挡块; 0.75 - 1 mm <sup>2</sup> ; 5件/条; 深灰色	<a href="http://www.wago.com/2002-172">www.wago.com/2002-172</a>
<b>clamps</b>		
	<b>型号: 209-105</b> 连接器; 银色	<a href="http://www.wago.com/209-105">www.wago.com/209-105</a>
	<b>型号: 210-281</b> 连接器; 蓝色	<a href="http://www.wago.com/210-281">www.wago.com/210-281</a>
<b>check</b>		
	<b>型号: 2009-174</b> 测试插头适配器; 适于测试插头4 mm Ø; 用于测试 TOPJOB® S 轨道式端子板; 灰色	<a href="http://www.wago.com/2009-174">www.wago.com/2009-174</a>
	<b>型号: 2009-182</b> 测试插头; 适用最大 2.5 mm <sup>2</sup> ; 可不使用任何工具与单根测试导线 ( 0.08 - 2.5 mm <sup>2</sup> ) 连接; 灰色	<a href="http://www.wago.com/2009-182">www.wago.com/2009-182</a>
	<b>型号: 210-136</b> 测试插头; 2 mm Ø; 带500 mm长电缆; 红色	<a href="http://www.wago.com/210-136">www.wago.com/210-136</a>
<b>assembling</b>		
	<b>型号: 2009-304</b> 汇流条支架; 不适合用作终端挡块; 适于 DIN 35 导轨; 厚度 1.5 mm; 蓝色	<a href="http://www.wago.com/2009-304">www.wago.com/2009-304</a>
	<b>型号: 2009-305</b> 汇流条支架; 有终端挡块功能和可拆卸隔板; 适于 DIN 35 导轨; 厚度 7.5 mm; 蓝色	<a href="http://www.wago.com/2009-305">www.wago.com/2009-305</a>
<b>General accessories</b>		
	<b>型号: 2003-7300</b> 锁定器; 防止滑块的误操作; 卡装式; 适用端子系列 : 2003; 橙色	<a href="http://www.wago.com/2003-7300">www.wago.com/2003-7300</a>
<b>N-busbar</b>		
	<b>型号: 210-133</b> 汇流条; 镀锡; 长度 1000 mm; Cu 10 mm x 3 mm; 白色	<a href="http://www.wago.com/210-133">www.wago.com/210-133</a>
	<b>型号: 777-303</b> N-汇流条防护罩; 长度 1000 mm; 透明	<a href="http://www.wago.com/777-303">www.wago.com/777-303</a>
<b>Carrier rail</b>		
	<b>型号: 210-112</b> 钢质导轨; 35 x 7.5 mm; 厚度 1 mm; 长度 2 m; 带孔; 符合 EN 60715标准; "孔宽25 mm; 银色	<a href="http://www.wago.com/210-112">www.wago.com/210-112</a>
	<b>型号: 210-113</b> 钢质导轨; 35 x 7.5 mm; 厚度 1 mm; 长度 2 m; 不带孔; 符合 EN 60715标准; 银色	<a href="http://www.wago.com/210-113">www.wago.com/210-113</a>
	<b>型号: 210-114</b> 钢质导轨; 35 x 15 mm; 厚度 1.5 mm; 长度 2 m; 不带孔; 类似于EN 60715; 银色	<a href="http://www.wago.com/210-114">www.wago.com/210-114</a>
	<b>型号: 210-115</b> 钢质导轨; 35 x 7.5 mm; 厚度 1 mm; 长度 2 m; 带孔; 符合 EN 60715标准; "孔宽18 mm; 银色	<a href="http://www.wago.com/210-115">www.wago.com/210-115</a>

变更声明。 敬请关注进一步的产品说明文件！

WAGO Electronic (Tianjin) Co., Ltd.  
No.5, Quan Hui Road  
Wuqing Development Area | Tianjin 301700  
Tel.: +86 22 59677688 | Fax: +86 22 59617668  
Email: [info-cn@wago.com](mailto:info-cn@wago.com)

您有关于我们产品的任何问题吗？  
我们非常乐意接听您的来电， +86 (022) 59677688。



	<b>型号: 210-118</b> 钢质导轨; 35 x 15 mm; 厚度 2.3 mm; 长度 2 m; 不带孔; 符合 EN 60715标准; 银色	<a href="http://www.wago.com/210-118">www.wago.com/210-118</a>
	<b>型号: 210-196</b> 铝质导轨; 35 x 8.2 mm; 厚度 1.6 mm; 长度 2 m; 不带孔; 类似于EN 60715; 银色	<a href="http://www.wago.com/210-196">www.wago.com/210-196</a>
	<b>型号: 210-197</b> 钢质导轨; 35 x 15 mm; 厚度 1.5 mm; 长度 2 m; 带孔; 类似于EN 60715; 银色	<a href="http://www.wago.com/210-197">www.wago.com/210-197</a>
	<b>型号: 210-198</b> 铜质导轨; 35 x 15 mm; 厚度 2.3 mm; 长度 2 m; 不带孔; 符合 EN 60715标准; 铜色	<a href="http://www.wago.com/210-198">www.wago.com/210-198</a>
<b>Jumper</b>		
	<b>型号: 2002-400</b> 连续跨接器; 2插脚; 绝缘; 浅灰色	<a href="http://www.wago.com/2002-400">www.wago.com/2002-400</a>
	<b>型号: 2002-402</b> 跨接器; 2插脚; 绝缘; 浅灰色	<a href="http://www.wago.com/2002-402">www.wago.com/2002-402</a>
	<b>型号: 2002-402/000-005</b> 跨接器; 2插脚; 绝缘; 红色	<a href="http://www.wago.com/2002-402/000-005">www.wago.com/2002-402/000-005</a>
	<b>型号: 2002-402/000-006</b> 跨接器; 2插脚; 绝缘; 蓝色	<a href="http://www.wago.com/2002-402/000-006">www.wago.com/2002-402/000-006</a>
	<b>型号: 2002-403</b> 跨接器; 3插脚; 绝缘; 浅灰色	<a href="http://www.wago.com/2002-403">www.wago.com/2002-403</a>
	<b>型号: 2002-403/000-005</b> 跨接器; 3插脚; 绝缘; 红色	<a href="http://www.wago.com/2002-403/000-005">www.wago.com/2002-403/000-005</a>
	<b>型号: 2002-403/000-006</b> 跨接器; 3插脚; 绝缘; 蓝色	<a href="http://www.wago.com/2002-403/000-006">www.wago.com/2002-403/000-006</a>
	<b>型号: 2002-404</b> 跨接器; 4插脚; 绝缘; 浅灰色	<a href="http://www.wago.com/2002-404">www.wago.com/2002-404</a>
	<b>型号: 2002-404/000-005</b> 跨接器; 4插脚; 绝缘; 红色	<a href="http://www.wago.com/2002-404/000-005">www.wago.com/2002-404/000-005</a>
	<b>型号: 2002-404/000-006</b> 跨接器; 4插脚; 绝缘; 蓝色	<a href="http://www.wago.com/2002-404/000-006">www.wago.com/2002-404/000-006</a>
	<b>型号: 2002-405</b> 跨接器; 5插脚; 绝缘; 浅灰色	<a href="http://www.wago.com/2002-405">www.wago.com/2002-405</a>

变更声明。敬请关注进一步的产品说明文件！

WAGO Electronic (Tianjin) Co., Ltd.  
No.5, Quan Hui Road  
Wuqing Development Area | Tianjin 301700  
Tel.: +86 22 59677688 | Fax: +86 22 59617668  
Email: [info-cn@wago.com](mailto:info-cn@wago.com)

您有关于我们产品的任何问题吗？  
我们非常乐意接听您的来电， +86 (022) 59677688。

	<b>型号: 2002-405/000-005</b> 跨接器; 5插脚; 绝缘; 红色	<a href="http://www.wago.com/2002-405/000-005">www.wago.com/2002-405/000-005</a>
	<b>型号: 2002-405/000-006</b> 跨接器; 5插脚; 绝缘; 蓝色	<a href="http://www.wago.com/2002-405/000-006">www.wago.com/2002-405/000-006</a>
	<b>型号: 2002-405/011-000</b> 起点跨接器; 3插脚; 绝缘; 浅灰色	<a href="http://www.wago.com/2002-405/011-000">www.wago.com/2002-405/011-000</a>
	<b>型号: 2002-406</b> 跨接器; 6插脚; 绝缘; 浅灰色	<a href="http://www.wago.com/2002-406">www.wago.com/2002-406</a>
	<b>型号: 2002-406/000-005</b> 跨接器; 6插脚; 绝缘; 红色	<a href="http://www.wago.com/2002-406/000-005">www.wago.com/2002-406/000-005</a>
	<b>型号: 2002-406/000-006</b> 跨接器; 6插脚; 绝缘; 蓝色	<a href="http://www.wago.com/2002-406/000-006">www.wago.com/2002-406/000-006</a>
	<b>型号: 2002-406/020-000</b> 三角形接法跨接器; 绝缘; 浅灰色	<a href="http://www.wago.com/2002-406/020-000">www.wago.com/2002-406/020-000</a>
	<b>型号: 2002-407</b> 跨接器; 7插脚; 绝缘; 浅灰色	<a href="http://www.wago.com/2002-407">www.wago.com/2002-407</a>
	<b>型号: 2002-407/000-005</b> 跨接器; 7插脚; 绝缘; 红色	<a href="http://www.wago.com/2002-407/000-005">www.wago.com/2002-407/000-005</a>
	<b>型号: 2002-407/000-006</b> 跨接器; 7插脚; 绝缘; 蓝色	<a href="http://www.wago.com/2002-407/000-006">www.wago.com/2002-407/000-006</a>
	<b>型号: 2002-408</b> 跨接器; 8插脚; 绝缘; 浅灰色	<a href="http://www.wago.com/2002-408">www.wago.com/2002-408</a>
	<b>型号: 2002-408/000-005</b> 跨接器; 8插脚; 绝缘; 红色	<a href="http://www.wago.com/2002-408/000-005">www.wago.com/2002-408/000-005</a>
	<b>型号: 2002-408/000-006</b> 跨接器; 8插脚; 绝缘; 蓝色	<a href="http://www.wago.com/2002-408/000-006">www.wago.com/2002-408/000-006</a>
	<b>型号: 2002-409</b> 跨接器; 9插脚; 绝缘; 浅灰色	<a href="http://www.wago.com/2002-409">www.wago.com/2002-409</a>

变更声明。 敬请关注进一步的产品说明文件！

WAGO Electronic (Tianjin) Co., Ltd.  
No.5, Quan Hui Road  
Wuqing Development Area | Tianjin 301700  
Tel.: +86 22 59677688 | Fax: +86 22 59617668  
Email: [info-cn@wago.com](mailto:info-cn@wago.com)

您有关于我们产品的任何问题吗？  
我们非常乐意接听您的来电， +86 (022) 59677688。

	<b>型号: 2002-409/000-005</b> 跨接器; 9插脚; 绝缘; 红色	<a href="http://www.wago.com/2002-409/000-005">www.wago.com/2002-409/000-005</a>
	<b>型号: 2002-409/000-006</b> 跨接器; 9插脚; 绝缘; 蓝色	<a href="http://www.wago.com/2002-409/000-006">www.wago.com/2002-409/000-006</a>
	<b>型号: 2002-410</b> 跨接器; 10插脚; 绝缘; 浅灰色	<a href="http://www.wago.com/2002-410">www.wago.com/2002-410</a>
	<b>型号: 2002-410/000-005</b> 跨接器; 10插脚; 绝缘; 红色	<a href="http://www.wago.com/2002-410/000-005">www.wago.com/2002-410/000-005</a>
	<b>型号: 2002-410/000-006</b> 跨接器; 10插脚; 绝缘; 蓝色	<a href="http://www.wago.com/2002-410/000-006">www.wago.com/2002-410/000-006</a>
	<b>型号: 2002-423</b> 连续跨接器; 从1到3; 绝缘; 浅灰色	<a href="http://www.wago.com/2002-423">www.wago.com/2002-423</a>
	<b>型号: 2002-423/000-005</b> 连续跨接器; 从1到3; 绝缘; 红色	<a href="http://www.wago.com/2002-423/000-005">www.wago.com/2002-423/000-005</a>
	<b>型号: 2002-423/000-006</b> 连续跨接器; 从1到3; 绝缘; 蓝色	<a href="http://www.wago.com/2002-423/000-006">www.wago.com/2002-423/000-006</a>
	<b>型号: 2002-433</b> 跨接器; 从1到3; 绝缘; 浅灰色	<a href="http://www.wago.com/2002-433">www.wago.com/2002-433</a>
	<b>型号: 2002-434</b> 跨接器; 从1到4; 绝缘; 浅灰色	<a href="http://www.wago.com/2002-434">www.wago.com/2002-434</a>
	<b>型号: 2002-435</b> 跨接器; 从1到5; 绝缘; 浅灰色	<a href="http://www.wago.com/2002-435">www.wago.com/2002-435</a>
	<b>型号: 2002-436</b> 跨接器; 从1到6; 绝缘; 浅灰色	<a href="http://www.wago.com/2002-436">www.wago.com/2002-436</a>
	<b>型号: 2002-437</b> 跨接器; 从1到7; 绝缘; 浅灰色	<a href="http://www.wago.com/2002-437">www.wago.com/2002-437</a>
	<b>型号: 2002-438</b> 跨接器; 从1到8; 绝缘; 浅灰色	<a href="http://www.wago.com/2002-438">www.wago.com/2002-438</a>
	<b>型号: 2002-439</b> 跨接器; 从1到9; 绝缘; 浅灰色	<a href="http://www.wago.com/2002-439">www.wago.com/2002-439</a>
	<b>型号: 2002-440</b> 跨接器; 从1到10; 绝缘; 浅灰色	<a href="http://www.wago.com/2002-440">www.wago.com/2002-440</a>

变更声明。敬请关注进一步的产品说明文件！

WAGO Electronic (Tianjin) Co., Ltd.  
No.5, Quan Hui Road  
Wuqing Development Area | Tianjin 301700  
Tel.: +86 22 59677688 | Fax: +86 22 59617668  
Email: info-cn@wago.com

您有关于我们产品的任何问题吗？  
我们非常乐意接听您的来电， +86 (022) 59677688。

	<b>型号: 2002-472</b> 交错跨接器; 2插脚; 绝缘; 浅灰色	<a href="http://www.wago.com/2002-472">www.wago.com/2002-472</a>
	<b>型号: 2002-473</b> 交错跨接器; 3插脚; 绝缘; 浅灰色	<a href="http://www.wago.com/2002-473">www.wago.com/2002-473</a>
	<b>型号: 2002-473/011-000</b> 交错跨接器; 2插脚; 从1到3; 绝缘; 浅灰色	<a href="http://www.wago.com/2002-473/011-000">www.wago.com/2002-473/011-000</a>
	<b>型号: 2002-474</b> 交错跨接器; 4插脚; 绝缘; 浅灰色	<a href="http://www.wago.com/2002-474">www.wago.com/2002-474</a>
	<b>型号: 2002-475</b> 交错跨接器; 5插脚; 绝缘; 浅灰色	<a href="http://www.wago.com/2002-475">www.wago.com/2002-475</a>
	<b>型号: 2002-475/011-000</b> 交错跨接器; 3插脚; 绝缘; 浅灰色	<a href="http://www.wago.com/2002-475/011-000">www.wago.com/2002-475/011-000</a>
	<b>型号: 2002-476</b> 交错跨接器; 6插脚; 绝缘; 浅灰色	<a href="http://www.wago.com/2002-476">www.wago.com/2002-476</a>
	<b>型号: 2002-477</b> 交错跨接器; 7插脚; 绝缘; 浅灰色	<a href="http://www.wago.com/2002-477">www.wago.com/2002-477</a>
	<b>型号: 2002-477/011-000</b> 交错跨接器; 绝缘; 浅灰色	<a href="http://www.wago.com/2002-477/011-000">www.wago.com/2002-477/011-000</a>
	<b>型号: 2002-478</b> 交错跨接器; 8插脚; 绝缘; 浅灰色	<a href="http://www.wago.com/2002-478">www.wago.com/2002-478</a>
	<b>型号: 2002-479</b> 交错跨接器; 9插脚; 绝缘; 浅灰色	<a href="http://www.wago.com/2002-479">www.wago.com/2002-479</a>
	<b>型号: 2002-479/011-000</b> 交错跨接器; 绝缘; 浅灰色	<a href="http://www.wago.com/2002-479/011-000">www.wago.com/2002-479/011-000</a>
	<b>型号: 2002-480</b> 交错跨接器; 10插脚; 绝缘; 浅灰色	<a href="http://www.wago.com/2002-480">www.wago.com/2002-480</a>
	<b>型号: 2002-481</b> 交错跨接器; 11插脚; 绝缘; 浅灰色	<a href="http://www.wago.com/2002-481">www.wago.com/2002-481</a>
	<b>型号: 2002-481/011-000</b> 交错跨接器; 绝缘; 浅灰色	<a href="http://www.wago.com/2002-481/011-000">www.wago.com/2002-481/011-000</a>
	<b>型号: 2002-482</b> 交错跨接器; 12插脚; 绝缘; 浅灰色	<a href="http://www.wago.com/2002-482">www.wago.com/2002-482</a>
	<b>型号: 210-103</b>	

变更声明。敬请关注进一步的产品说明文件！

WAGO Electronic (Tianjin) Co., Ltd.  
No.5, Quan Hui Road  
Wuqing Development Area | Tianjin 301700  
Tel.: +86 22 59677688 | Fax: +86 22 59617668  
Email: [info-cn@wago.com](mailto:info-cn@wago.com)

您有关于我们产品的任何问题吗？  
我们非常乐意接听您的来电，+86 (022) 59677688。

	导线型跨接器; 绝缘; 黑色	<a href="http://www.wago.com/210-103">www.wago.com/210-103</a>
	<b>型号: 210-123</b> 导线型跨接器; 绝缘; 蓝色	<a href="http://www.wago.com/210-123">www.wago.com/210-123</a>
<b>Push-In type wire jumper</b>		
	<b>型号: 2009-412</b> 推入式跨接器; 绝缘; 长度60 mm; 黑色	<a href="http://www.wago.com/2009-412">www.wago.com/2009-412</a>
	<b>型号: 2009-414</b> 推入式跨接器; 1.5 mm <sup>2</sup> ; 绝缘; 长度110 mm; 黑色	<a href="http://www.wago.com/2009-414">www.wago.com/2009-414</a>
	<b>型号: 2009-414/000-005</b> 推入式跨接器; 1.5 mm <sup>2</sup> ; 绝缘; 长度110 mm; 黑色	<a href="http://www.wago.com/2009-414/000-005">www.wago.com/2009-414/000-005</a>
	<b>型号: 2009-414/000-006</b> 推入式跨接器; 绝缘; 长度110 mm; 黑色	<a href="http://www.wago.com/2009-414/000-006">www.wago.com/2009-414/000-006</a>
	<b>型号: 2009-416</b> 推入式跨接器; 1.5 mm <sup>2</sup> ; 绝缘; 长度250 mm; 黑色	<a href="http://www.wago.com/2009-416">www.wago.com/2009-416</a>
<b>tools</b>		
	<b>型号: 2009-309</b> 操作工具; 刀口尺寸 : 3.5 x 0.5mm 和 2.5 x 0.4mm; 适用TOPJOB®S 建筑物电气安装用接线端子	<a href="http://www.wago.com/2009-309">www.wago.com/2009-309</a>
	<b>型号: 2009-310</b> 操作工具; 刀口尺寸 : 3.5 x 0.5 mm 和 5.5 x 0.8 mm; 适用TOPJOB®S 建筑物电气安装用接线端子; 绿色	<a href="http://www.wago.com/2009-310">www.wago.com/2009-310</a>
	<b>型号: 210-658</b> 操作工具; 刀口尺寸 : 3.5 x 0.5 mm; 带有绝缘手柄; 弯角; 短; 多种颜色	<a href="http://www.wago.com/210-658">www.wago.com/210-658</a>
	<b>型号: 210-720</b> 操作工具; 刀口尺寸 : 3.5 x 0.5 mm; 带有绝缘手柄; 多种颜色	<a href="http://www.wago.com/210-720">www.wago.com/210-720</a>
<b>ferrule</b>		
	<b>型号: 216-241</b> 冷压接头; 标识套管 , 适用截面积 0.5 mm <sup>2</sup> / AWG 20; 绝缘; 电镀锡; 电解铜; 气密压接; 符合DIN 46288-4 /09.09标准; 白色	<a href="http://www.wago.com/216-241">www.wago.com/216-241</a>
	<b>型号: 216-242</b> 冷压接头; 标识套管 , 适用截面积 0.75 mm <sup>2</sup> / AWG 18; 绝缘; 电镀锡; 电解铜; 气密压接; 符合DIN 46288-4 /09.09标准; 灰色	<a href="http://www.wago.com/216-242">www.wago.com/216-242</a>
	<b>型号: 216-243</b> 冷压接头; 套管 , 适于1 mm <sup>2</sup> / AWG 18; 绝缘; 电镀锡; 电解铜; 气密压接; 符合DIN 46288-4/09.09标准; 红色	<a href="http://www.wago.com/216-243">www.wago.com/216-243</a>
	<b>型号: 216-244</b> 冷压接头; 套管 , 适于1.5 mm <sup>2</sup> / AWG 16; 绝缘; 电镀锡; 电解铜; 气密压接; 符合DIN 46288-4/09.09标准; 黑色	<a href="http://www.wago.com/216-244">www.wago.com/216-244</a>
	<b>型号: 216-246</b> 冷压接头; 套管 , 适于2.5 mm <sup>2</sup> / AWG 14; 绝缘; 电镀锡; 电解铜; 气密压接; 符合DIN 46288-4/09.09标准; 蓝色	<a href="http://www.wago.com/216-246">www.wago.com/216-246</a>

变更声明。 敬请关注进一步的产品说明文件！

WAGO Electronic (Tianjin) Co., Ltd.  
No.5, Quan Hui Road  
Wuqing Development Area | Tianjin 301700  
Tel.: +86 22 59677688 | Fax: +86 22 59617668  
Email: [info-cn@wago.com](mailto:info-cn@wago.com)

您有关于我们产品的任何问题吗？  
我们非常乐意接听您的来电， +86 (022) 59677688。



**型号: 216-262**

冷压接头; 标识套管, 适用截面积 0.75 mm<sup>2</sup> / AWG 18; 绝缘; 电镀锡; 电解铜; 气密压接; 符合DIN 46288-4 /09.09标准; 灰色 [www.wago.com/216-262](http://www.wago.com/216-262)



**型号: 216-263**

冷压接头; 套管, 适于1 mm<sup>2</sup> / AWG 18; 绝缘; 电镀锡; 电解铜; 气密压接; 符合DIN 46288-4/09.09标准; 红色 [www.wago.com/216-263](http://www.wago.com/216-263)



**型号: 216-264**

冷压接头; 套管, 适于1.5 mm<sup>2</sup> / AWG 16; 绝缘; 电镀锡; 电解铜; 气密压接; 符合DIN 46288-4/09.09标准; 黑色 [www.wago.com/216-264](http://www.wago.com/216-264)



**型号: 216-266**

冷压接头; 套管, 适于2.5 mm<sup>2</sup> / AWG 14; 绝缘; 电镀锡; 电解铜; 气密压接; 符合DIN 46288-4/09.09标准; 蓝色 [www.wago.com/216-266](http://www.wago.com/216-266)

**下载  
文档**

**Bid Text**

2003-7641 docx - Datei	2019年4月29日	docx 15.2 kB	下载
2003-7641 X81 - Datei	2019年4月29日	xml 4.3 kB	下载

**Additional Information**

Technical explanations	2019年4月3日	pdf 2.2 MB	下载
------------------------	-----------	---------------	----

**CAD/CAE-Data**

**CAD data**

2D/3D Models 2003-7641	URL	下载
------------------------	-----	----

**CAE data**

EPLAN Data Portal 2003-7641	URL	下载
ZUKEN Portal 2003-7641	URL	下载
WSCAD Universe 2003-7641	URL	下载

**Environmental Product Compliance**

变更声明。 敬请关注进一步的产品说明文件！

WAGO Electronic (Tianjin) Co., Ltd.  
No.5, Quan Hui Road  
Wuqing Development Area | Tianjin 301700  
Tel.: +86 22 59677688 | Fax: +86 22 59617668  
Email: [info-cn@wago.com](mailto:info-cn@wago.com)

您有关于我们产品的任何问题吗？  
我们非常乐意接听您的来电， +86 (022) 59677688。

## Compliance Search

Environmental Product Compliance 2003-7641

URL

下载

多层电气安装用接线端子; 带有操作孔; 2.5 mm<sup>2</sup>; 带有N线可分断滑块; NT/L/PE; Push-in CAGE CLAMP®; 2,50 mm<sup>2</sup>; 灰色

## Installation Notes

### 连接导线

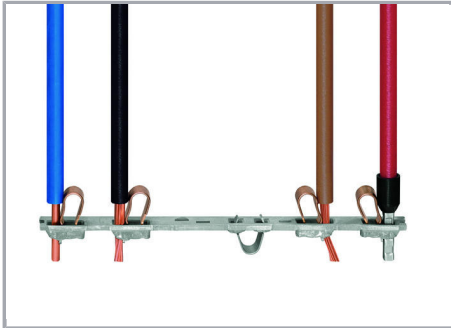

All conductor types at a glance

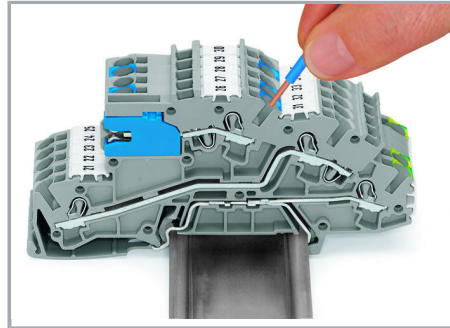

Inserting a conductor via push-in termination.

Solid conductors with cross-sections from either one size above, or up to two sizes below, the rated cross-section can be simply pushed in – no tools needed.

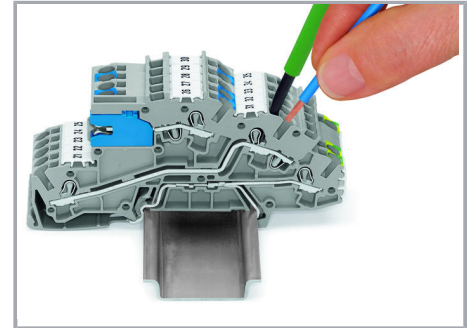

Inserting a conductor via operating tool.

Connecting fine-stranded conductors without ferrules, or small cross-sectional conductors that cannot be pushed in, is performed similarly to the original CAGE CLAMP® – just use an operating tool.

### 跨接

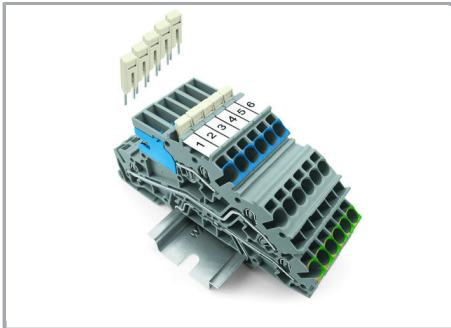

Adjacent Jumpers for Continuous Commoning (2002-400)

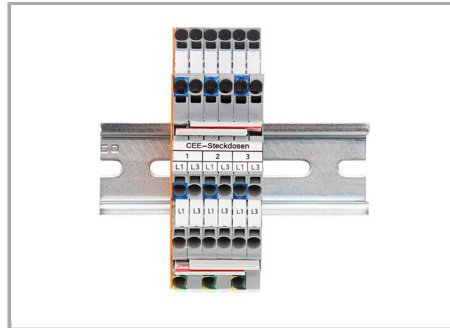

Commoning two potentials in one single jumper slot via extremely slim staggered jumpers.

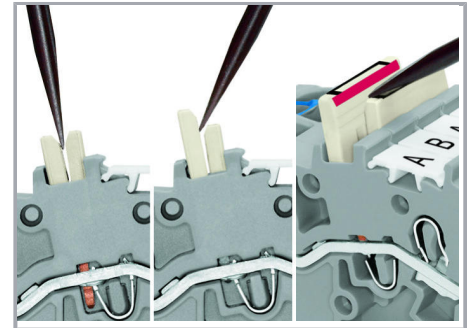

Removing a staggered jumper:

Insert the operating tool between the staggered jumpers, then lift up the jumper.

变更声明。 敬请关注进一步的产品说明文件！

WAGO Electronic (Tianjin) Co., Ltd.  
No.5, Quan Hui Road  
Wuqing Development Area | Tianjin 301700  
Tel.: +86 22 59677688 | Fax: +86 22 59617668  
Email: info-cn@wago.com

您有关于我们产品的任何问题吗？  
我们非常乐意接听您的来电， +86 (022) 59677688。



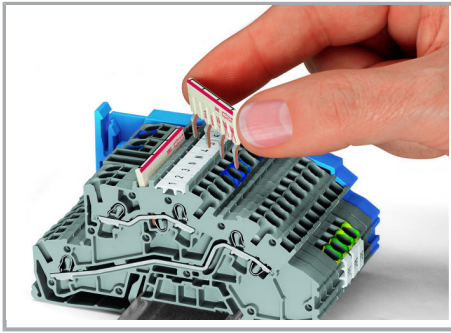

Orient the staggered jumpers' red stripes on the inside.

Insert the staggered jumper and push down until it hits the backstop.

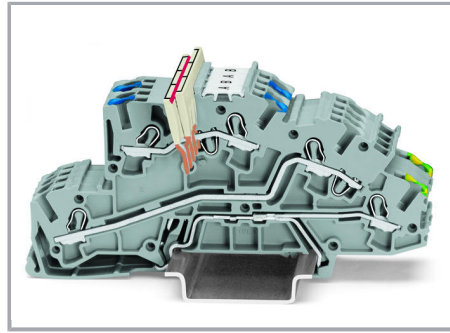

Orient the staggered jumpers' red stripes on the inside.

Insert the staggered jumper and push down until it hits the backstop.

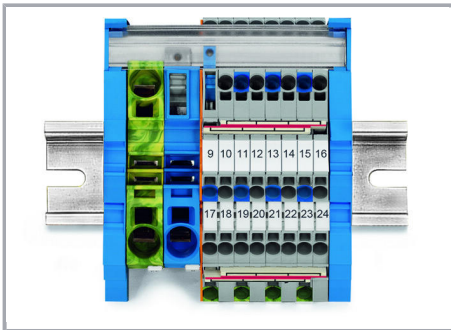
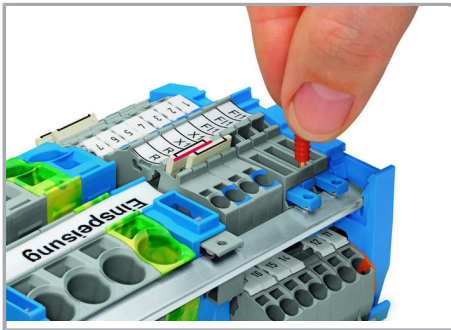

Mounting busbars on busbar carriers: Insert busbar ends onto large busbar carriers (2009-305) or onto supply terminal blocks with an integrated busbar carrier.

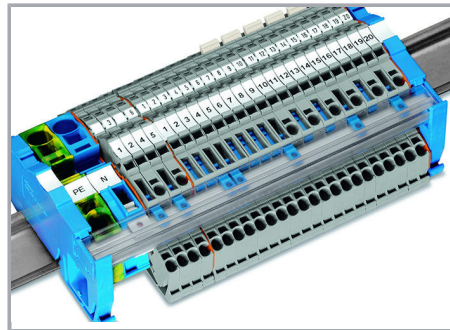

The busbar transparent cover (Item No. 777-303) protects the busbar against accidental contact and makes it easy to see which terminal blocks are connected to the busbar.

变更声明。 敬请关注进一步的产品说明文件！

WAGO Electronic (Tianjin) Co., Ltd.  
No.5, Quan Hui Road  
Wuqing Development Area | Tianjin 301700  
Tel.: +86 22 59677688 | Fax: +86 22 59617668  
Email: [info-cn@wago.com](mailto:info-cn@wago.com)

您有关于我们产品的任何问题吗？  
我们非常乐意接听您的来电， +86 (022) 59677688。



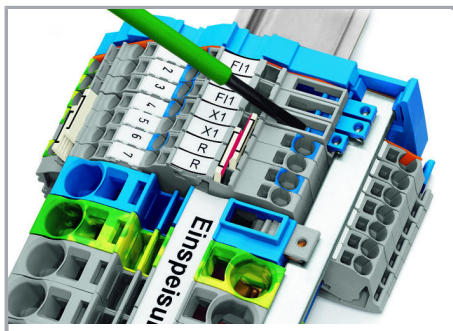

Tool-operated N-disconnect slide link

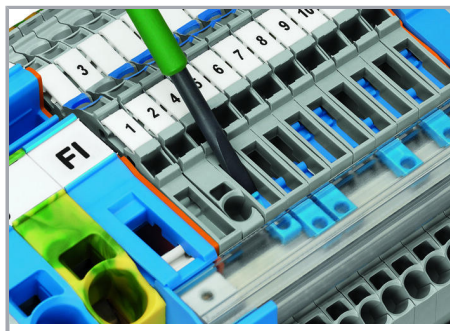

Tool-operated N-disconnect slide link

## 产品系列

### TOPJOB® S

TOPJOB® S: In various industrial applications and modern building installations, WAGO's wide and versatile range of rail-mount terminal blocks provides more than just reliable electrical connections.

[显示该系列的所有产品。](#)

变更声明。 敬请关注进一步的产品说明文件！

WAGO Electronic (Tianjin) Co., Ltd.  
No.5, Quan Hui Road  
Wuqing Development Area | Tianjin 301700  
Tel.: +86 22 59677688 | Fax: +86 22 59617668  
Email: [info-cn@wago.com](mailto:info-cn@wago.com)

您有关于我们产品的任何问题吗？  
我们非常乐意接听您的来电， +86 (022) 59677688。