

规格书 | 型号: 2003-6641

多层电气安装用接线端子; 带有操作孔; 2.5 mm²; 带有刀型分断器; NT/L/PE;
Push-in CAGE CLAMP®; 2,50 mm²; 灰色

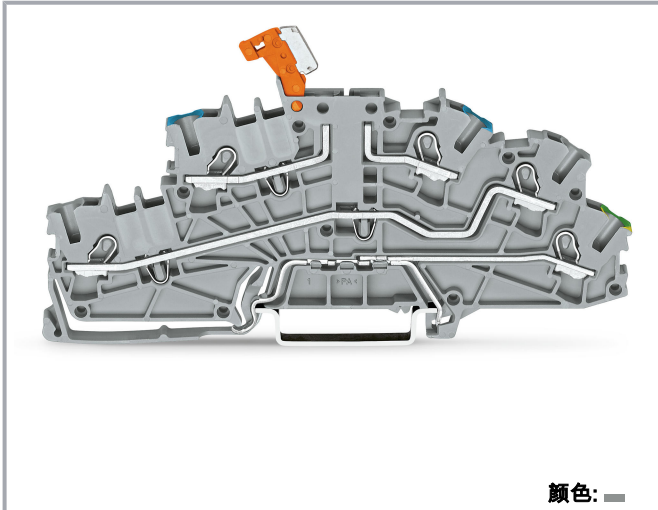

www.wago.com/2003-6641



颜色: —

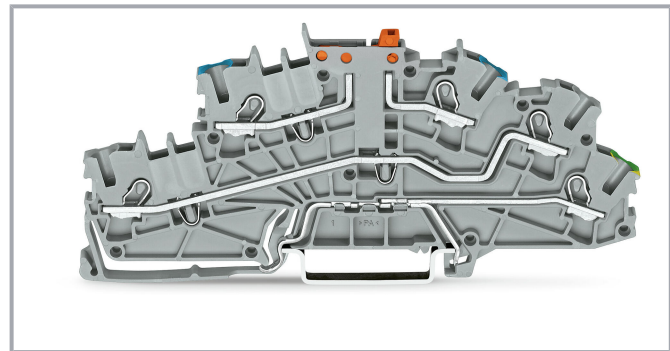
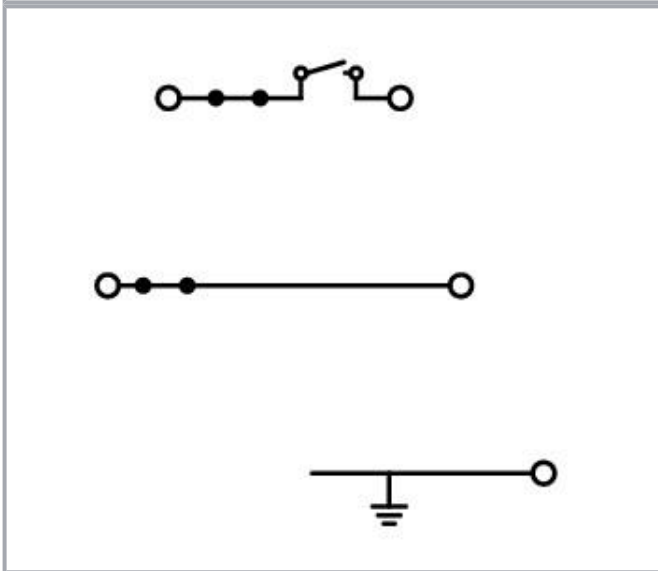
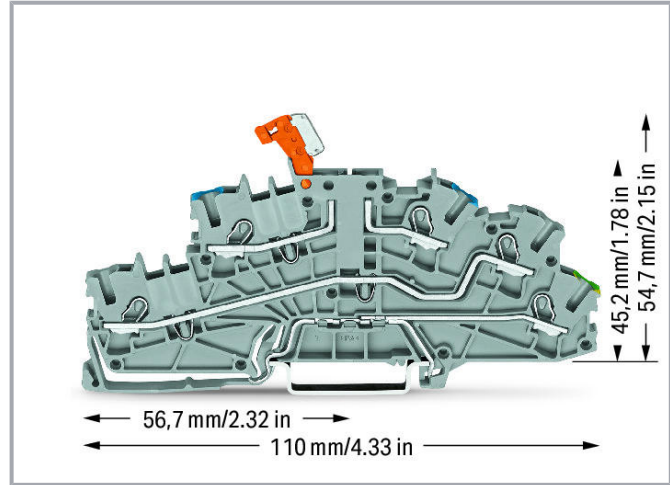

数据

电气参数

Ratings per IEC/EN

额定电气参数(注)

电位对地

变更声明。 敬请关注进一步的产品说明文件！

WAGO Electronic (Tianjin) Co., Ltd.
No.5, Quan Hui Road
Wuqing Development Area | Tianjin 301700
Tel.: +86 22 59677688 | Fax: +86 22 59617668
Email: info-cn@wago.com

您有关于我们产品的任何问题吗？
我们非常乐意接听您的来电， +86 (022) 59677688。

额定电压(III/3)	250 V
额定浪涌电压(III/3)	4 kV
额定电流	20 A
额定电气参数(注) 2	电位间
额定电压(III/3) 2	400 V
额定浪涌电压(III/3) 2	6 kV
额定电流2	25 A
图例(额定电气参数)	(III / 3) \triangle 过电压类别III/污染等级3

Approvals per UL

认证	UL 1059
额定电压 UL(Use Group B)	300 V
额定电流 UL(Use Group B)	20 A
额定电压 UL(Use Group C)	300 V
额定电流 UL(Use Group C)	20 A
额定电压 UL(Use Group D)	300 V
额定电流 UL(Use Group D)	20 A

Approvals per CSA

认证	C22.2 No 158
额定电压 CSA (Use Group B)	300 V
额定电流 CSA (Use Group B)	20 A
额定电压 CSA (Use Group D)	150 V
额定电流 CSA (Use Group D)	15 A

接线参数

连接技术	直插型笼式弹簧接线单元(Push-in CAGE CLAMP®)
执行类型	推入式 操作工具
可连接导线材料	铜
额定导线截面积	2.5 mm ²
单股导线	0.25 ... 4 mm ² / 22 ... 12 AWG
单股导线 ; 可直接插入	0.75 ... 4 mm ² / 18 ... 12 AWG
细多股导线	0.25 ... 4 mm ² / 22 ... 12 AWG
细多股导线 ; 加有带绝缘护套的冷压接头	0.25 ... 2.5 mm ² / 22 ... 14 AWG
细多股导线 ; 加有冷压接头 ; 可直接插入	1 ... 2.5 mm ² / 18 ... 14 AWG
说明(导线截面积)	横截面较小的导线也可以直接插入,具体取决于导线特性。

变更声明。 敬请关注进一步的产品说明文件 !

WAGO Electronic (Tianjin) Co., Ltd.
No.5, Quan Hui Road
Wuqing Development Area | Tianjin 301700
Tel.: +86 22 59677688 | Fax: +86 22 59617668
Email: info-cn@wago.com

您有关于我们产品的任何问题吗?
我们非常乐意接听您的来电, +86 (022) 59677688。

剥线长度	10 ... 12 mm / 0.39 ... 0.47 英寸
连接点总数	5
电位总数量	3
层数	3
接线类型	正面接线

Geometrical Data

宽度	5.2 mm / 0.205 inch
高度	110 mm / 4.331 inch
以DIN导轨的上边线为基准的深度	54.7 mm / 2.154 inch

机械参数

电位标记	NTi/L/PE
设计	弯角型
安装方式	DIN-35型导轨
标记位	中央/侧面标记位

材料参数

颜色	灰色
绝缘材料	尼龙66 (PA 66)
火灾荷载	0.309 MJ
重量	20.4 g

商业数据

Product Group	22 (TOPJOB S)
包装类型	BOX
原产国	CN
GTIN	4050821322030
海关税号	85365080900

认证 / 证书

船级社认证

标识	认证	其他认证信息	认证名称
	CCA DEKRA Certification B.V.	EN 60947	71- 113530

变更声明。敬请关注进一步的产品说明文件！

WAGO Electronic (Tianjin) Co., Ltd.
No.5, Quan Hui Road
Wuqing Development Area | Tianjin 301700
Tel.: +86 22 59677688 | Fax: +86 22 59617668
Email: info-cn@wago.com

您关于我们产品的任何问题吗？
我们非常乐意接听您的来电， +86 (022) 59677688。



CCA
DEKRA Certification B.V.

EN 60947

NTR NL-
7828



CSA
DEKRA Certification B.V.

C22.2 No. 158

70111102

UL-Approvals

标识	认证	其他认证信息	认证名称
	UL Underwriters Laboratories Inc.	UL 1059	20190402- E45172

所需附件

End plate

型号: 2003-6692

端板和隔板; 厚度 0.8 mm; 橙色

www.wago.com/2003-6692

适用产品

ferrule



型号: 216-241

冷压接头; 标识套管, 适用截面积 0.5 mm² / AWG 20; 绝缘; 电镀锡; 电解铜; 气密压接; 符合DIN 46288-4 /09.09标准; 白色 www.wago.com/216-241



型号: 216-242

冷压接头; 标识套管, 适用截面积 0.75 mm² / AWG 18; 绝缘; 电镀锡; 电解铜; 气密压接; 符合DIN 46288-4 /09.09标准; 灰色 www.wago.com/216-242



型号: 216-243

冷压接头; 套管, 适于1 mm² / AWG 18; 绝缘; 电镀锡; 电解铜; 气密压接; 符合DIN 46288-4/09.09标准; 红色 www.wago.com/216-243



型号: 216-244

冷压接头; 套管, 适于1.5 mm² / AWG 16; 绝缘; 电镀锡; 电解铜; 气密压接; 符合DIN 46288-4/09.09标准; 黑色 www.wago.com/216-244



型号: 216-246

冷压接头; 套管, 适于2.5 mm² / AWG 14; 绝缘; 电镀锡; 电解铜; 气密压接; 符合DIN 46288-4/09.09标准; 蓝色 www.wago.com/216-246



型号: 216-262

冷压接头; 标识套管, 适用截面积 0.75 mm² / AWG 18; 绝缘; 电镀锡; 电解铜; 气密压接; 符合DIN 46288-4 /09.09标准; 灰色 www.wago.com/216-262

变更声明。 敬请关注进一步的产品说明文件！

WAGO Electronic (Tianjin) Co., Ltd.
No.5, Quan Hui Road
Wuqing Development Area | Tianjin 301700
Tel.: +86 22 59677688 | Fax: +86 22 59617668
Email: info-cn@wago.com

您有关于我们产品的任何问题吗？
我们非常乐意接听您的来电， +86 (022) 59677688。

 **型号: 216-263** www.wago.com/216-263
冷压接头; 套管, 适于1 mm² / AWG 18; 绝缘; 电镀锡; 电解铜; 气密压接; 符合DIN 46288-4/09.09标准; 红色

 **型号: 216-264** www.wago.com/216-264
冷压接头; 套管, 适于1.5 mm² / AWG 16; 绝缘; 电镀锡; 电解铜; 气密压接; 符合DIN 46288-4/09.09标准; 黑色

 **型号: 216-266** www.wago.com/216-266
冷压接头; 套管, 适于2.5 mm² / AWG 14; 绝缘; 电镀锡; 电解铜; 气密压接; 符合DIN 46288-4/09.09标准; 蓝色

assembling

 **型号: 2009-304** www.wago.com/2009-304
汇流条支架; 不适合用作终端挡块; 适于 DIN 35 导轨; 厚度 1.5 mm; 蓝色

型号: 2009-305 www.wago.com/2009-305
汇流条支架; 有终端挡块功能和可拆卸隔板; 适于 DIN 35 导轨; 厚度 7.5 mm; 蓝色

Insulation stop

 **型号: 2002-171** www.wago.com/2002-171
绝缘挡块; 0.25 - 0.5 mm²; 5件/条; 浅灰色

 **型号: 2002-172** www.wago.com/2002-172
绝缘挡块; 0.75 - 1 mm²; 5件/条; 深灰色

Push-In type wire jumper

 **型号: 2009-412** www.wago.com/2009-412
推入式跨接器; 绝缘; 长度60 mm; 黑色

 **型号: 2009-414** www.wago.com/2009-414
推入式跨接器; 1.5 mm²; 绝缘; 长度110 mm; 黑色

 **型号: 2009-414/000-005** www.wago.com/2009-414/000-005
推入式跨接器; 1.5 mm²; 绝缘; 长度110 mm; 黑色

 **型号: 2009-414/000-006** www.wago.com/2009-414/000-006
推入式跨接器; 绝缘; 长度110 mm; 黑色

 **型号: 2009-416** www.wago.com/2009-416
推入式跨接器; 1.5 mm²; 绝缘; 长度250 mm; 黑色

Carrier rail

 **型号: 210-112** www.wago.com/210-112
钢质导轨; 35 x 7.5 mm; 厚度 1 mm; 长度 2 m; 带孔; 符合 EN 60715标准; "孔宽25 mm; 银色

 **型号: 210-113** www.wago.com/210-113
钢质导轨; 35 x 7.5 mm; 厚度 1 mm; 长度 2 m; 不带孔; 符合 EN 60715标准; 银色

 **型号: 210-114** www.wago.com/210-114
钢质导轨; 35 x 15 mm; 厚度 1.5 mm; 长度 2 m; 不带孔; 类似于EN 60715; 银色

 **型号: 210-115** www.wago.com/210-115

变更声明。敬请关注进一步的产品说明文件！

WAGO Electronic (Tianjin) Co., Ltd.
No.5, Quan Hui Road
Wuqing Development Area | Tianjin 301700
Tel.: +86 22 59677688 | Fax: +86 22 59617668
Email: info-cn@wago.com

您有关于我们产品的任何问题吗？
我们非常乐意接听您的来电，+86 (022) 59677688。

钢质导轨; 35 x 7.5 mm; 厚度 1 mm; 长度 2 m; 带孔; 符合 EN 60715标准; "孔宽18 mm; 银色

	型号: 210-118 钢质导轨; 35 x 15 mm; 厚度 2.3 mm; 长度 2 m; 不带孔; 符合 EN 60715标准; 银色	www.wago.com/210-118
---	---	--

	型号: 210-196 铝质导轨; 35 x 8.2 mm; 厚度 1.6 mm; 长度 2 m; 不带孔; 类似于EN 60715; 银色	www.wago.com/210-196
---	--	--

	型号: 210-197 钢质导轨; 35 x 15 mm; 厚度 1.5 mm; 长度 2 m; 带孔; 类似于EN 60715; 银色	www.wago.com/210-197
---	--	--

	型号: 210-198 铜质导轨; 35 x 15 mm; 厚度 2.3 mm; 长度 2 m; 不带孔; 符合 EN 60715标准; 铜色	www.wago.com/210-198
---	---	--

Jumper

	型号: 2002-400 连续跨接器; 2插脚; 绝缘; 浅灰色	www.wago.com/2002-400
---	--	--

	型号: 2002-402 跨接器; 2插脚; 绝缘; 浅灰色	www.wago.com/2002-402
---	--	--

	型号: 2002-402/000-005 跨接器; 2插脚; 绝缘; 红色	www.wago.com/2002-402/000-005
---	---	--

	型号: 2002-402/000-006 跨接器; 2插脚; 绝缘; 蓝色	www.wago.com/2002-402/000-006
--	---	--

	型号: 2002-403 跨接器; 3插脚; 绝缘; 浅灰色	www.wago.com/2002-403
---	--	--

	型号: 2002-403/000-005 跨接器; 3插脚; 绝缘; 红色	www.wago.com/2002-403/000-005
---	---	--

	型号: 2002-403/000-006 跨接器; 3插脚; 绝缘; 蓝色	www.wago.com/2002-403/000-006
---	---	--

	型号: 2002-404 跨接器; 4插脚; 绝缘; 浅灰色	www.wago.com/2002-404
---	--	--

	型号: 2002-404/000-005 跨接器; 4插脚; 绝缘; 红色	www.wago.com/2002-404/000-005
---	---	--















	型号: 2002-404/000-006 跨接器; 4插脚; 绝缘; 蓝色	www.wago.com/2002-404/000-006
---	---	--

	型号: 2002-405 跨接器; 5插脚; 绝缘; 浅灰色	www.wago.com/2002-405
---	--	--

变更声明。 敬请关注进一步的产品说明文件！

WAGO Electronic (Tianjin) Co., Ltd.
No.5, Quan Hui Road
Wuqing Development Area | Tianjin 301700
Tel.: +86 22 59677688 | Fax: +86 22 59617668
Email: info-cn@wago.com

您有关于我们产品的任何问题吗？
我们非常乐意接听您的来电， +86 (022) 59677688。

	型号: 2002-405/000-005 跨接器; 5插脚; 绝缘; 红色	www.wago.com/2002-405/000-005
	型号: 2002-405/000-006 跨接器; 5插脚; 绝缘; 蓝色	www.wago.com/2002-405/000-006
	型号: 2002-405/011-000 起点跨接器; 3插脚; 绝缘; 浅灰色	www.wago.com/2002-405/011-000
	型号: 2002-406 跨接器; 6插脚; 绝缘; 浅灰色	www.wago.com/2002-406
	型号: 2002-406/000-005 跨接器; 6插脚; 绝缘; 红色	www.wago.com/2002-406/000-005
	型号: 2002-406/000-006 跨接器; 6插脚; 绝缘; 蓝色	www.wago.com/2002-406/000-006
	型号: 2002-406/020-000 三角形接法跨接器; 绝缘; 浅灰色	www.wago.com/2002-406/020-000
	型号: 2002-407 跨接器; 7插脚; 绝缘; 浅灰色	www.wago.com/2002-407
	型号: 2002-407/000-005 跨接器; 7插脚; 绝缘; 红色	www.wago.com/2002-407/000-005
	型号: 2002-407/000-006 跨接器; 7插脚; 绝缘; 蓝色	www.wago.com/2002-407/000-006
	型号: 2002-408 跨接器; 8插脚; 绝缘; 浅灰色	www.wago.com/2002-408
	型号: 2002-408/000-005 跨接器; 8插脚; 绝缘; 红色	www.wago.com/2002-408/000-005
	型号: 2002-408/000-006 跨接器; 8插脚; 绝缘; 蓝色	www.wago.com/2002-408/000-006
	型号: 2002-409 跨接器; 9插脚; 绝缘; 浅灰色	www.wago.com/2002-409
	型号: 2002-409/000-005 跨接器; 9插脚; 绝缘; 红色	www.wago.com/2002-409/000-005

变更声明。敬请关注进一步的产品说明文件！

WAGO Electronic (Tianjin) Co., Ltd.
No.5, Quan Hui Road
Wuqing Development Area | Tianjin 301700
Tel.: +86 22 59677688 | Fax: +86 22 59617668
Email: info-cn@wago.com

















您关于我们产品的任何问题吗？
我们非常乐意接听您的来电， +86 (022) 59677688。

	型号: 2002-409/000-006 跨接器; 9插脚; 绝缘; 蓝色	www.wago.com/2002-409/000-006
	型号: 2002-410 跨接器; 10插脚; 绝缘; 浅灰色	www.wago.com/2002-410
	型号: 2002-410/000-005 跨接器; 10插脚; 绝缘; 红色	www.wago.com/2002-410/000-005
	型号: 2002-410/000-006 跨接器; 10插脚; 绝缘; 蓝色	www.wago.com/2002-410/000-006
	型号: 2002-423 连续跨接器; 从1到3; 绝缘; 浅灰色	www.wago.com/2002-423
	型号: 2002-423/000-005 连续跨接器; 从1到3; 绝缘; 红色	www.wago.com/2002-423/000-005
	型号: 2002-423/000-006 连续跨接器; 从1到3; 绝缘; 蓝色	www.wago.com/2002-423/000-006
	型号: 2002-433 跨接器; 从1到3; 绝缘; 浅灰色	www.wago.com/2002-433
	型号: 2002-434 跨接器; 从1到4; 绝缘; 浅灰色	www.wago.com/2002-434
	型号: 2002-435 跨接器; 从1到5; 绝缘; 浅灰色	www.wago.com/2002-435
	型号: 2002-436 跨接器; 从1到6; 绝缘; 浅灰色	www.wago.com/2002-436
	型号: 2002-437 跨接器; 从1到7; 绝缘; 浅灰色	www.wago.com/2002-437
	型号: 2002-438 跨接器; 从1到8; 绝缘; 浅灰色	www.wago.com/2002-438
	型号: 2002-439 跨接器; 从1到9; 绝缘; 浅灰色	www.wago.com/2002-439
	型号: 2002-440 跨接器; 从1到10; 绝缘; 浅灰色	www.wago.com/2002-440
	型号: 2002-472 交错跨接器; 2插脚; 绝缘; 浅灰色	www.wago.com/2002-472

变更声明。敬请关注进一步的产品说明文件！

WAGO Electronic (Tianjin) Co., Ltd.
No.5, Quan Hui Road
Wuqing Development Area | Tianjin 301700
Tel.: +86 22 59677688 | Fax: +86 22 59617668
Email: info-cn@wago.com

您有关于我们产品的任何问题吗？
我们非常乐意接听您的来电， +86 (022) 59677688。

	型号: 2002-473 交错跨接器; 3插脚; 绝缘; 浅灰色	www.wago.com/2002-473
	型号: 2002-473/011-000 交错跨接器; 2插脚; 从1到3; 绝缘; 浅灰色	www.wago.com/2002-473/011-000
	型号: 2002-474 交错跨接器; 4插脚; 绝缘; 浅灰色	www.wago.com/2002-474
	型号: 2002-475 交错跨接器; 5插脚; 绝缘; 浅灰色	www.wago.com/2002-475
	型号: 2002-475/011-000 交错跨接器; 3插脚; 绝缘; 浅灰色	www.wago.com/2002-475/011-000
	型号: 2002-476 交错跨接器; 6插脚; 绝缘; 浅灰色	www.wago.com/2002-476
	型号: 2002-477 交错跨接器; 7插脚; 绝缘; 浅灰色	www.wago.com/2002-477
	型号: 2002-477/011-000 交错跨接器; 绝缘; 浅灰色	www.wago.com/2002-477/011-000
	型号: 2002-478 交错跨接器; 8插脚; 绝缘; 浅灰色	www.wago.com/2002-478
	型号: 2002-479 交错跨接器; 9插脚; 绝缘; 浅灰色	www.wago.com/2002-479
	型号: 2002-479/011-000 交错跨接器; 绝缘; 浅灰色	www.wago.com/2002-479/011-000
	型号: 2002-480 交错跨接器; 10插脚; 绝缘; 浅灰色	www.wago.com/2002-480
	型号: 2002-481 交错跨接器; 11插脚; 绝缘; 浅灰色	www.wago.com/2002-481
	型号: 2002-481/011-000 交错跨接器; 绝缘; 浅灰色	www.wago.com/2002-481/011-000
	型号: 2002-482 交错跨接器; 12插脚; 绝缘; 浅灰色	www.wago.com/2002-482
	型号: 210-103 导线型跨接器; 绝缘; 黑色	www.wago.com/210-103
	型号: 210-123	

变更声明。敬请关注进一步的产品说明文件！

WAGO Electronic (Tianjin) Co., Ltd.
No.5, Quan Hui Road
Wuqing Development Area | Tianjin 301700
Tel.: +86 22 59677688 | Fax: +86 22 59617668
Email: info-cn@wago.com

您有关于我们产品的任何问题吗？
我们非常乐意接听您的来电， +86 (022) 59677688。

mm	导线型跨接器; 绝缘; 蓝色	www.wago.com/210-123
tools		
	型号: 2009-309 操作工具; 刀口尺寸: 3.5 x 0.5mm 和 2.5 x 0.4mm; 适用TOPJOB@S 建筑物电气安装用接线端子	www.wago.com/2009-309
	型号: 2009-310 操作工具; 刀口尺寸: 3.5 x 0.5 mm 和 5.5 x 0.8 mm; 适用TOPJOB@S 建筑物电气安装用接线端子; 绿色	www.wago.com/2009-310
	型号: 210-658 操作工具; 刀口尺寸: 3.5 x 0.5 mm; 带有绝缘手柄; 弯角; 短; 多种颜色	www.wago.com/210-658
	型号: 210-720 操作工具; 刀口尺寸: 3.5 x 0.5 mm; 带有绝缘手柄; 多种颜色	www.wago.com/210-720
check		
	型号: 2003-499 测试插头适配器 N/L; 用于2003-6641和2003-6640多层电气安装用接线端子; 适用于垂直测试插孔; 2极; 灰色	www.wago.com/2003-499
	型号: 2003-500 测试插头适配器 N; 用于2003-6641和2003-6640多层电气安装用接线端子; 适用于垂直测试插孔; 1极; 灰色	www.wago.com/2003-500
	型号: 2009-174 测试插头适配器; 适于测试插头4 mm Ø; 用于测试 TOPJOB@ S 轨道式端子板; 灰色	www.wago.com/2009-174
	型号: 2009-182 测试插头; 适用最大 2.5 mm ² ; 可不使用任何工具与单根测试导线 (0.08 - 2.5 mm ²) 连接; 灰色	www.wago.com/2009-182
	型号: 210-136 测试插头; 2 mm Ø; 带500 mm长电缆; 红色	www.wago.com/210-136
Marking accessories		
	型号: 2009-110 标记条; 适于Smart Printer; 卷装; not stretchable; 空白; 卡装式; 白色	www.wago.com/2009-110
	型号: 2009-115 WMB-Inline; 适于Smart Printer; 每卷1500个标记; 5 - 5.2 mm可伸缩; 空白; 卡装式; 白色	www.wago.com/2009-115
	型号: 2009-115/000-002 WMB-Inline; 适于Smart Printer; 每卷1500个标记; 5 - 5.2 mm可伸缩; 空白; 卡装式; 黄色	www.wago.com/2009-115 /000-002
	型号: 2009-115/000-005 WMB-Inline; 适于Smart Printer; 每卷1500个标记; 5 - 5.2 mm可伸缩; 空白; 卡装式; 红色	www.wago.com/2009-115 /000-005
	型号: 2009-115/000-006 WMB-Inline; 适于Smart Printer; 每卷1500个标记; 5 - 5.2 mm可伸缩; 空白; 卡装式; 蓝色	www.wago.com/2009-115 /000-006
	型号: 2009-115/000-007 WMB-Inline; 适于Smart Printer; 每卷1500个标记; 5 - 5.2 mm可伸缩; 空白; 卡装式; 灰色	www.wago.com/2009-115 /000-007

变更声明。敬请关注进一步的产品说明文件！

WAGO Electronic (Tianjin) Co., Ltd.
No.5, Quan Hui Road
Wuqing Development Area | Tianjin 301700
Tel.: +86 22 59677688 | Fax: +86 22 59617668
Email: info-cn@wago.com





您有关于我们产品的任何问题吗？
我们非常乐意接听您的来电， +86 (022) 59677688。

<p>型号: 2009-115/000-012 WMB-Inline; 适于Smart Printer; 每卷1500个标记; 5 - 5.2 mm可伸缩; 空白; 卡装式; 橙色</p>	www.wago.com/2009-115/000-012
<p>型号: 2009-115/000-017 WMB-Inline; 适于Smart Printer; 每卷1500个标记; 5 - 5.2 mm可伸缩; 空白; 卡装式; 浅绿色</p>	www.wago.com/2009-115/000-017
<p>型号: 2009-115/000-023 WMB-Inline; 适于Smart Printer; 每卷1500个标记; 5 - 5.2 mm可伸缩; 空白; 卡装式; 绿色</p>	www.wago.com/2009-115/000-023
<p>型号: 2009-115/000-024 WMB-Inline; 适于Smart Printer; 每卷1500个标记; 5 - 5.2 mm可伸缩; 空白; 卡装式; 紫色</p>	www.wago.com/2009-115/000-024
<p>型号: 2009-145 Mini-WSB Inline; 适于Smart Printer; 每卷1700个标记; 5 - 5.2 mm可伸缩; 空白; 卡装式; 白色</p>	www.wago.com/2009-145
<p>型号: 2009-145/000-002 Mini-WSB Inline; 适于Smart Printer; 每卷1700个标记; 5 - 5.2 mm可伸缩; 空白; 卡装式; 黄色</p>	www.wago.com/2009-145/000-002
<p>型号: 2009-145/000-005 Mini-WSB Inline; 适于Smart Printer; 每卷1700个标记; 5 - 5.2 mm可伸缩; 空白; 卡装式; 红色</p>	www.wago.com/2009-145/000-005
<p>型号: 2009-145/000-006 Mini-WSB Inline; 适于Smart Printer; 每卷1700个标记; 5 - 5.2 mm可伸缩; 空白; 卡装式; 蓝色</p>	www.wago.com/2009-145/000-006
<p>型号: 2009-145/000-007 Mini-WSB Inline; 适于Smart Printer; 每卷1700个标记; 5 - 5.2 mm可伸缩; 空白; 卡装式; 灰色</p>	www.wago.com/2009-145/000-007
<p>型号: 2009-145/000-012 Mini-WSB Inline; 适于Smart Printer; 每卷1700个标记; 5 - 5.2 mm可伸缩; 空白; 卡装式; 橙色</p>	www.wago.com/2009-145/000-012
<p>型号: 2009-145/000-023 Mini-WSB Inline; 适于Smart Printer; 每卷1700个标记; 5 - 5.2 mm可伸缩; 空白; 卡装式; 绿色</p>	www.wago.com/2009-145/000-023
<p>型号: 2009-145/000-024 Mini-WSB Inline; 适于Smart Printer; 每卷1700个标记; 5 - 5.2 mm可伸缩; 空白; 卡装式; 紫色</p>	www.wago.com/2009-145/000-024
<p> 型号: 2009-191 组标记支架</p>	www.wago.com/2009-191
<p> 型号: 2009-192 组标记支架</p>	www.wago.com/2009-192

变更声明。敬请关注进一步的产品说明文件！

WAGO Electronic (Tianjin) Co., Ltd.
No.5, Quan Hui Road
Wuqing Development Area | Tianjin 301700
Tel.: +86 22 59677688 | Fax: +86 22 59617668
Email: info-cn@wago.com





您关于我们产品的任何问题吗？
我们非常乐意接听您的来电， +86 (022) 59677688。

	型号: 2009-193 组标记支架	www.wago.com/2009-193
	型号: 2009-198 适配器; 灰色	www.wago.com/2009-198
	型号: 248-501 Mini-WSB标记牌; 详见卡片; not stretchable; 空白; 卡装式; 白色	www.wago.com/248-501
	型号: 248-501/000-002 Mini-WSB标记牌; 详见卡片; not stretchable; 空白; 卡装式; 黄色	www.wago.com/248-501/000-002
	型号: 248-501/000-005 Mini-WSB标记牌; 详见卡片; not stretchable; 空白; 卡装式; 红色	www.wago.com/248-501/000-005
	型号: 248-501/000-006 Mini-WSB标记牌; 详见卡片; not stretchable; 空白; 卡装式; 蓝色	www.wago.com/248-501/000-006
	型号: 248-501/000-007 Mini-WSB标记牌; 详见卡片; not stretchable; 空白; 卡装式; 灰色	www.wago.com/248-501/000-007
	型号: 248-501/000-012 Mini-WSB标记牌; 详见卡片; not stretchable; 空白; 卡装式; 橙色	www.wago.com/248-501/000-012
	型号: 248-501/000-017 Mini-WSB标记牌; 详见卡片; not stretchable; 空白; 卡装式; 浅绿色	www.wago.com/248-501/000-017
	型号: 248-501/000-023 Mini-WSB标记牌; 详见卡片; not stretchable; 空白; 卡装式; 绿色	www.wago.com/248-501/000-023
	型号: 248-501/000-024 Mini-WSB标记牌; 详见卡片; not stretchable; 空白; 卡装式; 紫色	www.wago.com/248-501/000-024
	型号: 793-501 WMB标记卡; 详见卡片; not stretchable; 空白; 卡装式; 白色	www.wago.com/793-501
	型号: 793-501/000-002 WMB标记卡; 详见卡片; not stretchable; 空白; 卡装式; 黄色	www.wago.com/793-501/000-002
	型号: 793-501/000-005 WMB标记卡; 详见卡片; not stretchable; 空白; 卡装式; 红色	www.wago.com/793-501/000-005

变更声明。 敬请关注进一步的产品说明文件！

WAGO Electronic (Tianjin) Co., Ltd.
No.5, Quan Hui Road
Wuqing Development Area | Tianjin 301700
Tel.: +86 22 59677688 | Fax: +86 22 59617668
Email: info-cn@wago.com

您有关于我们产品的任何问题吗？
我们非常乐意接听您的来电， +86 (022) 59677688。

	型号: 793-501/000-006 WMB标记卡; 详见卡片; not stretchable; 空白; 卡装式; 蓝色	www.wago.com/793-501/000-006
	型号: 793-501/000-007 WMB标记卡; 详见卡片; not stretchable; 空白; 卡装式; 灰色	www.wago.com/793-501/000-007
	型号: 793-501/000-012 WMB标记卡; 详见卡片; not stretchable; 空白; 卡装式; 橙色	www.wago.com/793-501/000-012
	型号: 793-501/000-017 WMB标记卡; 详见卡片; not stretchable; 空白; 卡装式; 浅绿色	www.wago.com/793-501/000-017
	型号: 793-501/000-023 WMB标记卡; 详见卡片; not stretchable; 空白; 卡装式; 绿色	www.wago.com/793-501/000-023
	型号: 793-501/000-024 WMB标记卡; 详见卡片; not stretchable; 空白; 卡装式; 紫色	www.wago.com/793-501/000-024
	型号: 793-5501 WMB标记卡; 详见卡片; 用于接线端子厚度 5 - 17.5 mm; 5 - 5.2 mm可伸缩; 空白; 卡装式; 白色	www.wago.com/793-5501
	型号: 793-5501/000-002 WMB标记卡; 详见卡片; 用于接线端子厚度 5 - 17.5 mm; 5 - 5.2 mm可伸缩; 空白; 卡装式; 黄色	www.wago.com/793-5501/000-002
	型号: 793-5501/000-005 WMB标记卡; 详见卡片; 用于接线端子厚度 5 - 17.5 mm; 5 - 5.2 mm可伸缩; 空白; 卡装式; 红色	www.wago.com/793-5501/000-005
	型号: 793-5501/000-006 WMB标记卡; 详见卡片; 用于接线端子厚度 5 - 17.5 mm; 5 - 5.2 mm可伸缩; 空白; 卡装式; 蓝色	www.wago.com/793-5501/000-006
	型号: 793-5501/000-007 WMB标记卡; 详见卡片; 用于接线端子厚度 5 - 17.5 mm; 5 - 5.2 mm可伸缩; 空白; 卡装式; 灰色	www.wago.com/793-5501/000-007
	型号: 793-5501/000-012 WMB标记卡; 详见卡片; 用于接线端子厚度 5 - 17.5 mm; 5 - 5.2 mm可伸缩; 空白; 卡装式; 橙色	www.wago.com/793-5501/000-012
	型号: 793-5501/000-014 WMB标记卡; 详见卡片; 用于接线端子厚度 5 - 17.5 mm; 5 - 5.2 mm可伸缩; 空白; 卡装式; 棕色	www.wago.com/793-5501/000-014

变更声明。 敬请关注进一步的产品说明文件！

WAGO Electronic (Tianjin) Co., Ltd.
No.5, Quan Hui Road
Wuqing Development Area | Tianjin 301700
Tel.: +86 22 59677688 | Fax: +86 22 59617668
Email: info-cn@wago.com

您有关于我们产品的任何问题吗？
我们非常乐意接听您的来电， +86 (022) 59677688。

	型号: 793-5501/000-017 WMB标记卡; 详见卡片; 用于接线端子厚度 5 - 17.5 mm; 5 - 5.2 mm可伸缩; 空白; 卡装式; 绿色	www.wago.com/793-5501/000-017
	型号: 793-5501/000-023 WMB标记卡; 详见卡片; 用于接线端子厚度 5 - 17.5 mm; 5 - 5.2 mm可伸缩; 空白; 卡装式; 浅绿色	www.wago.com/793-5501/000-023
	型号: 793-5501/000-024 WMB标记卡; 详见卡片; 用于接线端子厚度 5 - 17.5 mm; 5 - 5.2 mm可伸缩; 空白; 卡装式; 紫色	www.wago.com/793-5501/000-024

下载 文档

Bid Text

2003-6641 X81 - Datei	2019年4月29日	xml 4.3 kB	下载
2003-6641 docx - Datei	2019年4月29日	docx 15.3 kB	下载

Additional Information

Technical explanations	2019年4月3日	pdf 2.2 MB	下载
------------------------	-----------	---------------	----

CAD/CAE-Data

CAD data

2D/3D Models 2003-6641	URL	下载
------------------------	-----	----

CAE data

EPLAN Data Portal 2003-6641	URL	下载
WSCAD Universe 2003-6641	URL	下载
ZUKEN Portal 2003-6641	URL	下载

变更声明。 敬请关注进一步的产品说明文件！

WAGO Electronic (Tianjin) Co., Ltd.
No.5, Quan Hui Road
Wuqing Development Area | Tianjin 301700
Tel.: +86 22 59677688 | Fax: +86 22 59617668
Email: info-cn@wago.com

您关于我们产品的任何问题吗？
我们非常乐意接听您的来电， +86 (022) 59677688。

Environmental Product Compliance

Compliance Search

Environmental Product Compliance 2003-6641

URL

下载

多层电气安装用接线端子; 带有操作孔; 2.5 mm²; 带有刀型分断器; NT/L/PE; Push-in CAGE CLAMP®; 2,50 mm²; 灰色

Installation Notes

连接导线

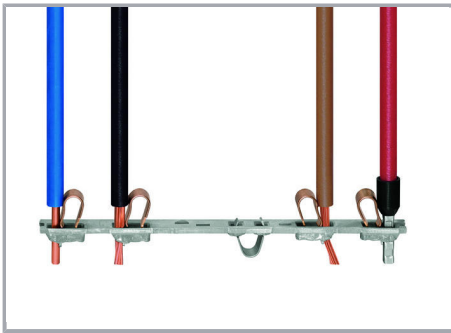

All conductor types at a glance

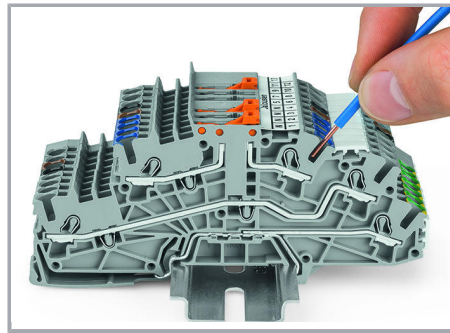

Inserting a conductor via push-in termination.

Solid conductors with cross-sections from either one size above, or up to two sizes below, the rated cross-section can be simply pushed in – no tools needed.

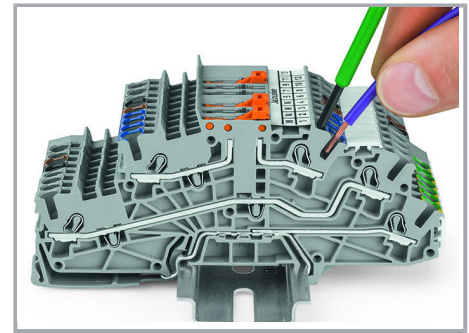

Inserting a conductor via operating tool.

Connecting fine-stranded conductors without ferrules, or small cross-sectional conductors that cannot be pushed in, is performed similarly to the original CAGE CLAMP® – just use an operating tool.

变更声明。敬请关注进一步的产品说明文件！

WAGO Electronic (Tianjin) Co., Ltd.
No.5, Quan Hui Road
Wuqing Development Area | Tianjin 301700
Tel.: +86 22 59677688 | Fax: +86 22 59617668
Email: info-cn@wago.com

您关于我们产品的任何问题吗？
我们非常乐意接听您的来电，+86 (022) 59677688。

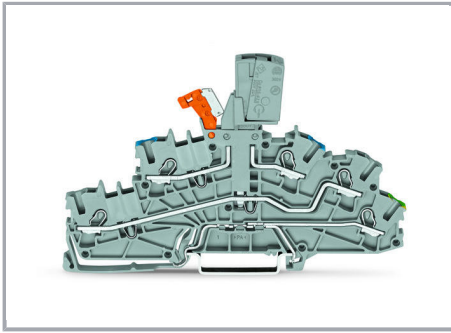

Multilevel installation terminal block (2003-6641) fitted with an N/L-test plug adapter (2003-499) for insulation resistance measurement of the connected N- and L-potentials

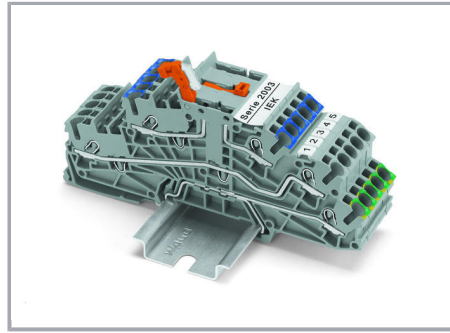

N-potential disconnection via N-knife disconnect within a terminal block assembly without a busbar.

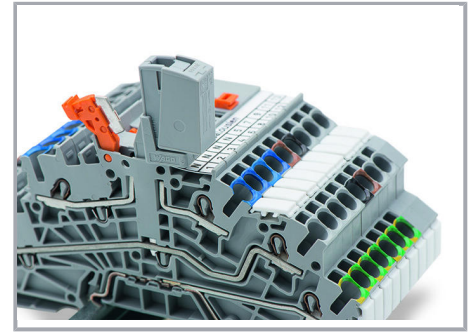

For multilevel installation terminal blocks with internal N-disconnection, test plug adapters can be inserted into the free vertical test slot when the N-potential is disconnected.

跨接

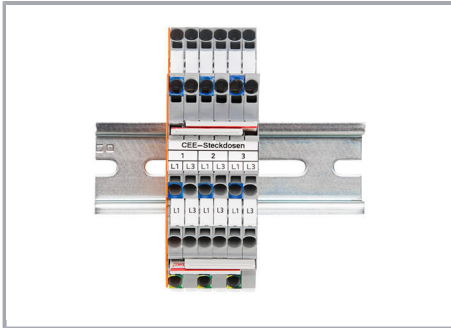

Commoning two potentials in one single jumper slot via extremely slim staggered jumpers.

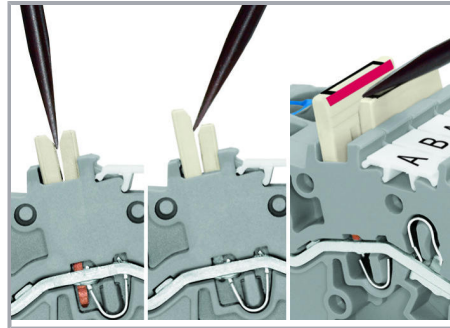

Removing a staggered jumper:

Insert the operating tool between the staggered jumpers, then lift up the jumper.

产品系列

TOPJOB® S

TOPJOB® S: In various industrial applications and modern building installations, WAGO's wide and versatile range of rail-mount terminal blocks provides more than just reliable electrical connections.

[显示该系列的所有产品。](#)

变更声明。 敬请关注进一步的产品说明文件！

WAGO Electronic (Tianjin) Co., Ltd.
No.5, Quan Hui Road
Wuqing Development Area | Tianjin 301700
Tel.: +86 22 59677688 | Fax: +86 22 59617668
Email: info-cn@wago.com

您有关于我们产品的任何问题吗？
我们非常乐意接听您的来电， +86 (022) 59677688。